

SPIN-ON FILTERS

**HYDRAULIC
FILTRATION**

CATALOGUE



MPFILTRI®

PASSION TO PERFORM



A WORLDWIDE LEADER IN THE FIELD OF HYDRAULIC FILTRATION EQUIPMENT.

Our company started life in 1964, when Bruno Pasotto decided to attempt to cater for the requests of a market still to be fully explored, with the study, design, development, production and marketing of a vast range of filters for hydraulic equipment, capable of satisfying the needs of manufacturers in all sectors. The quality of our products, our extreme competitiveness compared with major international producers and our constant activities of research, design and development has made us a worldwide leader in the field of hydraulic circuit filtering. Present for over 50 years in the market, we have played a truly decisive role in defining our sector, and by now we are a group capable of controlling our entire chain of production, monitoring all manufacturing processes to guarantee superior quality standards and to provide concrete solutions for the rapidly evolving needs of customers and the market.

HYDRAULIC FILTRATION PRODUCTS

1	page	INTRODUCTION
2	INDEX	
4	COMPANY PROFILE	
8	PRODUCT RANGE	
11	CONTAMINATION MANAGEMENT	
22	FILTER SIZING	
24	CORRECTIVE FACTOR	
28	FILTER SIZING SOFTWARE	

			up to Q_{max}	
30	page	SUCTION FILTERS	l/min	gpm
33	STR & MPA - MPM	Submerged suction filter, with bypass or magnetic filter	1000	264
40	SFEX	In-line filter with plastic bowl	100	26
51	SF2 250 - 350	Semi-submerged positive head suction filter, low flow rate	160	42
59	SF2 500	Semi-submerged positive head suction filter, high flow rate	700	185
709	CLOGGING INDICATORS			

			up to P_{max}		up to Q_{max}	
70	page	RETURN FILTERS	bar	psi	l/min	gpm
72	RFEX	Return filter, tank mounted filter suitable for all mineral oil and water glycol applications	16	232	260	69
82	MPFX	Tank top semi-immersed filter, standard filter element disassembly	8	116	900	238
110	MPLX	Tank top semi-immersed filter, standard filter element disassembly	10	145	1800	476
118	MPTX	Tank top semi-immersed filter, easy filter element disassembly	8	116	300	79
136	MFBX	Bowl assembly	8	116	700	185
145	MPF	Tank top semi-immersed filter, standard filter element disassembly	8	116	900	238
173	MPT	Tank top semi-immersed filter, easy filter element disassembly	8	116	300	79
191	MFB	Bowl assembly	8	116	700	185
199	MDH	Heavy industrial applications integrated in the tank - air separation	10	145	500	132
207	MPH	Tank top semi-immersed filter, standard filter element disassembly	10	145	3500	925
231	MPI	Tank top semi-immersed filter, standard filter element disassembly	10	145	3500	925
243	FRI	Tank top semi-immersed filter, easy filter element disassembly, it can be used also as in-line filter	20	290	2500	660
259	RF2	Semi-immersed under-head filter, easy filter element disassembly	20	290	615	162
266	ACCESSORIES					
710	CLOGGING INDICATORS					

			up to P_{max}		up to Q_{max}	
268	page	RETURN / SUCTION FILTERS	bar	psi	l/min	gpm
270	MRSX	Unique TANK TOP filter for mobile machinery, with combined filtration on return and suction to the inlet at the hydrostatic transmissions in closed circuit	10	145	250	66
285	LMP 124 MULTIPORT	Unique IN-LINE filter for mobile machinery, with combined filtration on return and suction to the inlet at the hydrostatic transmissions in closed circuit	80	1160	120	32
712	CLOGGING INDICATORS					

			up to P_{max}		up to Q_{max}	
292	page	SPIN-ON FILTERS	bar	psi	l/min	gpm
295	MPS	Low pressure filter, available with single cartridge (CS) for in-line or flange mounting or with two cartridge on the same axis on the opposite sides	12	174	365	96
311	MSH	In-line low and medium pressure filter available with single cartridge (CH)	35	508	195	52
714	CLOGGING INDICATORS					

318 page	LOW & MEDIUM PRESSURE FILTERS	up to P _{max}		up to Q _{max}		
		bar	psi	l/min	gpm	
320	LFEF	In-line filter with plastic bowl	16	232	300	79
331	LMP 110	In-line low & medium pressure filter, low to medium flow rate	80	1160	165	44
339	LMP 112 - 123 MULTIPORT	In-line filter with Multiport design for multiple choice connection	80	1160	175	46
355	LMP 210 - 211	In-line low & medium pressure filter, low flow rate	60	870	365	96
365	LPH 630	Off-line low pressure filter	10	145	1600	352
373	LMP 400 - 401 & 430 - 431	In-line low & medium pressure filter, high flow rate	60	870	780	206
385	LMP 950 - 951	In-line filter, available with 2 and up to 6 different heads	30	435	2400	634
393	LMP 952 - 953 - 954	In-line low pressure filter specifically designed to be mounted in series	25	363	4500	1189
405	LMD 211	In-line duplex medium pressure filter	60	870	200	53
413	LMD 400 - 401 & 431	In-line duplex low pressure filter	16	232	600	159
429	LMD 951	In-line duplex filter, available with 2 up to 6 different heads	16	232	1200	317
437		Filter elements designed according to DIN 24550				
439	LDP - LDD	In-line and duplex medium pressure filter	60	870	360	95
449	LMP 900 - 901	In-line low pressure filter	30	435	2000	528
457	LMP 902 - 903	In-line filter specifically designed to be mounted in series	20	290	3000	793
466	ACCESSORIES					
716	CLOGGING INDICATORS					

468 page	HIGH PRESSURE FILTERS	up to P _{max}		up to Q _{max}		
		bar	psi	l/min	gpm	
470	FMMX 050	Typical high pressure filter for mobile applications, low flow rate	420	6092	154	41
479	FMM	Typical high pressure filter for mobile applications, low flow rate	420	6092	300	79
489	FHA 051	Filter optimized for use in high pressure operating systems, low flow rate	560	8122	150	40
497	FMP 039	Filter high pressure, low flow rate applications	110	1595	80	21
505	FMP	Filter high pressure, high flow rate applications	320	4641	500	132
517	FHP	Typical high pressure filter for mobile applications, high flow rate	450	6527	630	166
537	FHM	High pressure filter with intermediate manifold construction	320	4641	400	106
555	FHB	High pressure for block mounting	320	4641	485	128
569	FHF 325	In-line manifold top mounting	350	5076	550	145
579	FHD	In-line duplex high pressure filter	350	5076	250	66
593	HPB	Pressure filter kits for integration in control manifolds	420	6092	300	79
717	CLOGGING INDICATORS					

602 page	STAINLESS STEEL HIGH PRESSURE FILTERS	up to P _{max}		up to Q _{max}		
		bar	psi	l/min	gpm	
605	FZP	In-line pressure filter with threaded mount	420	6092	160	42
615	FZH	In-line pressure filter with threaded mount for higher pressure	700	10153	80	21
625	FZX	In-line pressure filter with threaded mount up to 1000 bar	1000	14504	10	3
633	FZM	Manifold top mounting	320	4641	70	18
641	FZB	Manifold side mounting	320	4641	70	18
649	FZD	Duplex pressure filter for continuous operation requirements	350	5076	60	16
718	CLOGGING INDICATORS					

660 page	FILTERS FOR POTENTIALLY EXPLOSIVE ATMOSPHERE	up to P _{max}		up to Q _{max}		
		bar	psi	l/min	gpm	
663	FMMX 050	Typical high pressure filter for mobile applications, low flow rate	420	6092	154	41
671	FZP	In-line pressure filter with threaded mount	700	10153	80	21
681	FZH	In-line pressure filter with threaded mount for higher pressure	1000	14504	10	3
691	FZX	In-line pressure filter with threaded mount up to 1000 bar	320	4641	70	18
719	CLOGGING INDICATORS					

699 page	CLOGGING INDICATORS
704	QUICK REFERENCE GUIDE
708	DESIGNATION AND ORDERING CODES
720	TECHNICAL DATA

MARKET LEADER



Our work is based on a skillful interaction between advanced technology and fine workmanship, **customizing products according to specific market requests**, focusing strongly on innovation and quality, and following every step in the manufacturing of both standard and special products, fully respecting customer expectations.



Our customer-oriented philosophy, which enables us to satisfy all customer requests **rapidly and with personalized products**, makes us a **dynamic and flexible enterprise**. The possibility of constantly controlling and monitoring the entire production process is essential to allow us to guarantee the quality of our products.

WORLDWIDE PRESENCE

Our foreign Branches enable us to offer a diversified range of products that allow us to successfully face the aggressive challenge of international competition, and also to maintain a stable presence at a local level.

The Group boasts **9 business branches**



TECHNOLOGY

Our constant **quest for excellence in quality and technological innovation** allows us to offer only the best solutions and services for applications in many fields, including general industry, test rigs, lubrication, heavy engineering, renewable energies, naval engineering, offshore engineering, aviation systems, emerging technologies and mobile plant (i.e. tractors, excavators, concrete pumps, platforms).



AND PRODUCTION

Our high level of technological expertise means **we can rely entirely on our own resources, without resorting to external providers.** This in turn enables us to satisfy a growing number of customer requests, also exploiting our constantly updated range of machines and equipment, featuring **fully-automated workstations** capable of **24-hour production.**

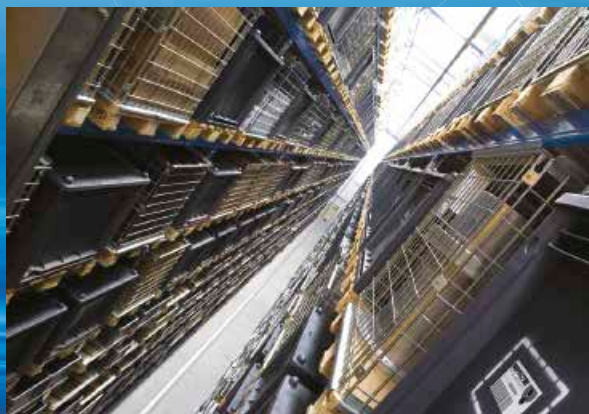



SUCTION FILTERS

Flow rates
up to 875 l/min

- Mounting:
- Tank immersed
 - In-Line
 - In tank with shut off valve
 - In tank with flooded suction

RETURN FILTERS

Flow rates
up to 3000 l/min

- Pressure
up to 20 bar
- Mounting:
- In-Line
 - Tank top
 - In single and duplex designs

RETURN / SUCTION FILTERS

Flow rates
up to 300 l/min

- Pressure
up to 80 bar
- Mounting:
- In-Line
 - Tank top

SPIN-ON FILTERS

Flow rates
up to 365 l/min

- Pressure
up to 35 bar
- Mounting:
- In-Line
 - Tank top

LOW & MEDIUM PRESSURE FILTERS

Flow rates
up to 3000 l/min

- Pressure
up to 80 bar
- Mounting:
- In-Line
 - Parallel manifold version
 - In single and duplex designs

HIGH PRESSURE FILTERS

Flow rates
up to 750 l/min

- Pressure from 110 bar
up to 560 bar
- Mounting:
- In-Line
 - Manifold
 - In single and duplex designs

PRODUCT RANGE

MP Filtri can offer a vast and articulated range of products for the global market, suitable for all industrial sectors using hydraulic equipment.

This includes filters (suction, return, return/suction, spin-on, pressure, stainless steel pressure, ATEX filters) and structural components (motor/pump bell-housings, transmission couplings, damping rings, foot brackets, aluminium tanks, cleaning covers).

We can provide all the skills and solutions required by the modern hydraulics industry to monitor contamination levels and other fluid conditions.

Mobile filtration units and a full range of accessories allow us to supply everything necessary for a complete service in the hydraulic circuits.



STAINLESS STEEL HIGH PRESSURE FILTERS

Flow rates up to 150 l/min

Pressure from 320 bar up to 1000 bar

- Mounting:
- In-Line
 - Manifold
 - In single and duplex designs

FILTERS FOR POTENTIALLY EXPLOSIVE ATMOSPHERE

Flow rates up to 154 l/min

Pressure from 420 bar up to 1000 bar

- Mounting:
- In-Line

CONTAMINATION CONTROL SOLUTIONS

- Off-line, in-line particle counters
- Off-line bottle sampling products
- Fully calibrated using relevant ISO standards
- A wide range of variants to support fluid types and communication protocols
- Mobile Filtration Units with flow rates from 15 l/min up to 200 l/min

POWER TRANSMISSION PRODUCTS

- Aluminium bell-housings for motors from 0.12 kW to 400 kW
- Couplings in Aluminium Cast Iron - Steel
- Damping rings
- Foot bracket
- Aluminium tanks
- Cleaning covers

TANK ACCESSORIES

- Oil filler and air breather plugs
- Optical and electrical level gauges
- Pressure gauge valve selectors
- Pipe fixing brackets
- Pressure gauges



CONTAMINATION MANAGEMENT

INDEX

	Page
① HYDRAULIC FLUIDS	12
② FLUIDS CONTAMINATION	12
③ FLUIDS COMPATIBILITY CHART	12
④ EFFECTS OF CONTAMINATION ON HYDRAULIC COMPONENTS	13
⑤ MEASURING THE SOLID CONTAMINATION LEVEL	13
⑥ FILTRATION TECHNOLOGIES	16
⑦ RECOMMENDED CONTAMINATION CLASSES	17
⑧ TYPES OF FILTERS	17
⑨ FILTER SIZING PARAMETERS	18
⑩ APPLICABLE STANDARDS FOR FILTER DEVELOPMENT	18
⑪ WATER IN HYDRAULIC AND LUBRICATING FLUIDS	19
⑫ THE ANTI-STATIC FILTERS zerospark+	20

1 HYDRAULIC FLUIDS

The fluid is the vector that transmits power, energy within an oleodynamic circuit. In addition to transmitting energy through the circuit, it also performs additional functions such as lubrication, protection and cooling of the surfaces.

The classification of fluids used in hydraulic systems is coded in many regulatory references, different Standards.

The most popular classification criterion divides them into the following families:

- MINERAL OILS

Commonly used oil derived fluids.

- FIRE RESISTANT FLUIDS

Fluids with intrinsic characteristics of incombustibility or high flash point.

- SYNTHETIC FLUIDS

Modified chemical products to obtain specific optimized features.

- ECOLOGICAL FLUIDS

Synthetic or vegetable origin fluids with high biodegradability characteristics.

The choice of fluid for an hydraulic system must take into account several parameters.

These parameters can adversely affect the performance of an hydraulic system, causing delay in the controls, pump cavitation, excessive absorption, excessive temperature rise, efficiency reduction, increased drainage, wear, jam/block or air intake in the plant.

The main properties that characterize hydraulic fluids and affect their choice are:

- DYNAMIC VISCOSITY

It identifies the fluid's resistance to sliding due to the impact of the particles forming it.

- KINEMATIC VISCOSITY

It is a widespread formal dimension in the hydraulic field.

It is calculated with the ratio between the dynamic viscosity and the fluid density.

Kinematic viscosity varies with temperature and pressure variations.

- VISCOSITY INDEX

This value expresses the ability of a fluid to maintain viscosity when the temperature changes.

A high viscosity index indicates the fluid's ability to limit viscosity variations by varying the temperature.

- FILTERABILITY INDEX

It is the value that indicates the ability of a fluid to cross the filter materials. A low filterability index could cause premature clogging of the filter material.

- WORKING TEMPERATURE

Working temperature affects the fundamental characteristics of the fluid. As already seen, some fluid characteristics, such as cinematic viscosity, vary with the temperature variation.

When choosing a hydraulic oil, must therefore be taken into account of the environmental conditions in which the machine will operate.

- COMPRESSIBILITY MODULE

Every fluid subjected to a pressure contracts, increasing its density.

The compressibility module identifies the increase in pressure required to cause a corresponding increase in density.

- HYDROLYTIC STABILITY

It is the characteristic that prevents galvanic pairs that can cause wear in the plant/system.

- ANTIOXIDANT STABILITY AND WEAR PROTECTION

These features translate into the capacity of a hydraulic oil to avoid corrosion of metal elements inside the system.

- HEAT TRANSFER CAPACITY

It is the characteristic that indicates the capacity of hydraulic oil to exchange heat with the surfaces and then cool them.

2 FLUID CONTAMINATION

Whatever the nature and properties of fluids, they are inevitably subject to contamination. Fluid contamination can have two origins:

- INITIAL CONTAMINATION

Caused by the introduction of contaminated fluid into the circuit, or by incorrect storage, transport or transfer operations.

- PROGRESSIVE CONTAMINATION

Caused by factors related to the operation of the system, such as metal surface wear, sealing wear, oxidation or degradation of the fluid, the introduction of contaminants during maintenance, corrosion due to chemical or electrochemical action between fluid and components, cavitation. The contamination of hydraulic systems can be of different nature:

- SOLID CONTAMINATION

For example rust, slag, metal particles, fibers, rubber particles, paint particles or additives

- LIQUID CONTAMINATION

For example, the presence of water due to condensation or external infiltration or acids

- GASEOUS CONTAMINATION

For example, the presence of air due to inadequate oil level in the tank, drainage in suction ducts, incorrect sizing of tubes or tanks.

3 FLUID COMPATIBILITY CHARTS

For general fluid compatibility with Contamination Monitoring Products the below rules can be used:

- For mineral oils, synthetic fluids and diesel - the 'M' type variant of unit is recommended.

- For water based/ subsea fluids & 'M' type fluids - the 'N' type variant of unit is recommended.

- For Aerospace phosphate esters, Skydrols® and aggressive fluids along with 'M' & 'N' type fluids - the 'S' type variant is recommended.

All fluids are required to be clear in appearance to allow light to penetrate unhindered.



For further and more detailed information on specific fluid compatibility please refer to the fluid compatibility list

④ EFFECTS OF CONTAMINATION ON HYDRAULIC COMPONENTS

Solid contamination is recognized as the main cause of malfunction, failure and early degradation in hydraulic systems. It is impossible to delete it completely, but it can be effectively controlled by appropriate devices.

CONTAMINATION IN PRESENCE OF LARGE TOLERANCES



CONTAMINATION IN PRESENCE OF NARROW TOLERANCES



Solid contamination mainly causes surface damage and component wear.

- ABRASION OF SURFACES
Cause of leakage through mechanical seals, reduction of system performance, failures.
- SURFACE EROSION
Cause of leakage through mechanical seals, reduction of system performance, variation in adjustment of control components, failures.
- ADHESION OF MOVING PARTS
Cause of failure due to lack of lubrication.
- DAMAGES DUE TO FATIGUE
Cause of breakdowns and components breakdown.

ABRASION



EROSION



ADHESION

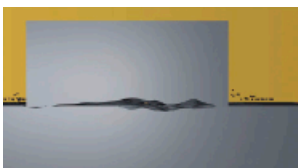

FATIGUE



Liquid contamination mainly results in decay of lubrication performance and protection of fluid surfaces.

DISSOLVED WATER

- INCREASING FLUID ACIDITY
Cause of surface corrosion and premature fluid oxidation
- GALVANIC COUPLE AT HIGH TEMPERATURES
Cause of corrosion

FREE WATER - ADDITIONAL EFFECTS

- DECAY OF LUBRICANT PERFORMANCE
Cause of rust and sludge formation, metal corrosion and increased solid contamination
- BATTERY COLONY CREATION
Cause of worsening in the filterability feature

- ICE CREATION AT LOW TEMPERATURES
Cause damage to the surface
- ADDITIVE DEPLETION
Free water retains polar additives

Gaseous contamination mainly results in decay of system performance.

- CUSHION SUSPENSION
Cause of increased noise and cavitation.
- FLUID OXIDATION
Cause of corrosion acceleration of metal parts.
- MODIFICATION OF FLUID PROPERTIES (COMPRESSIBILITY MODULE, DENSITY, VISCOSITY)
Cause of system's reduction of efficiency and of control. It is easy to understand how a system without proper contamination management is subject to higher costs than a system that is provided.
- MAINTENANCE
Increase maintenance activities, spare parts, machine stop costs.
- ENERGY AND EFFICIENCY
Efficiency and performance reduction due to friction, drainage, cavitation.

⑤ MEASURING THE SOLID CONTAMINATION LEVEL

The level of contamination of a system identifies the amount of contaminant contained in a fluid. This parameter refers to a unit volume of fluid. The level of contamination may be different at different points in the system. From the information in the previous paragraphs it is also apparent that the level of contamination is heavily influenced by the working conditions of the system, by its working years and by the environmental conditions.

What is the size of the contaminating particles that we must handle in our hydraulic circuit?

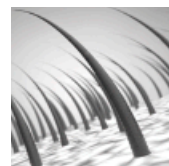

HUMAN HAIR (75 µm)

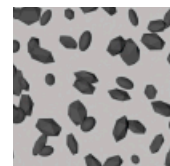

MINIMUM DIMENSION VISIBLE WITH HUMAN EYES (40 µm)

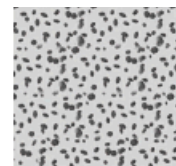

TYPICAL CONTAMINANT DIMENSION IN A HYDRAULIC CIRCUIT (4 - 14 µm)

Contamination level analysis is significant only if performed with a uniform and repeatable method, conducted with standard test methods and suitably calibrated equipment. To this end, ISO has issued a set of standards that allow tests to be conducted and express the measured values in the following ways.

- GRAVIMETRIC LEVEL - ISO 4405

The level of contamination is defined by checking the weight of particles collected by a laboratory membrane. The membrane must be cleaned, dried and desiccated, with fluid and conditions defined by the Standard. The volume of fluid is filtered through the membrane by using a suitable suction system. The weight of the contaminant is determined by checking the weight of the membrane before and after the fluid filtration.



CLEAN MEMBRANE

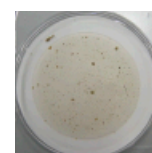

CONTAMINATED MEMBRANE

CONTAMINATION MANAGEMENT

- CUMULATIVE DISTRIBUTION OF THE PARTICLES SIZE - ISO 4406

The level of contamination is defined by counting the number of particles of certain dimensions per unit of volume of fluid. Measurement is performed by Contamination Monitoring Products (CMP).

Following the count, the contamination classes are determined, corresponding to the number of particles detected in the unit of fluid.

The most common classification methods follow ISO 4406 and SAE AS 4059 (Aerospace Sector) regulations.

NAS 1638 is still used although obsolete.

Classification example according to ISO 4406

The International Standards Organization standard ISO 4406 is the preferred method of quoting the number of solid contaminant particles in a sample. The level of contamination is defined by counting the number of particles of certain dimensions per unit of volume of fluid. The measurement is performed by Contamination Monitoring Products (CMP).

The numbers represent a code which identifies the number of particles of certain sizes in 1ml of fluid. Each code number has a particular size range. The first scale number represents the number of particles equal to or larger than 4 $\mu\text{m}_{(c)}$ per millilitre of fluid; The second scale number represents the number of particles equal to or larger than 6 $\mu\text{m}_{(c)}$ per millilitre of fluid; The third scale number represents the number of particles equal to or larger than 14 $\mu\text{m}_{(c)}$ per millilitre of fluid.

ISO 4406 - Allocation of Scale Numbers

Class	Number of particles per ml	
	Over	Up to
28	1 300 000	2 500 000
27	640 000	1 300 000
26	320 000	640 000
25	160 000	320 000
24	80 000	160 000
23	40 000	80 000
22	20 000	40 000
21	10 000	20 000
20	5 000	10 000
19	2 500	5 000
18	1 300	2 500
17	640	1 300
16	320	640
15	160	320
14	80	160
13	40	80
12	20	40
11	10	20
10	5	10
9	2.5	5
8	1.3	2.5
7	0.64	1.3
6	0.32	0.64
5	0.16	0.32
4	0.08	0.16
3	0.04	0.08
2	0.02	0.04
1	0.01	0.02
0	0	0.01

- > 4 $\mu\text{m}_{(c)}$ = 350 particles
 - > 6 $\mu\text{m}_{(c)}$ = 100 particles
 - > 14 $\mu\text{m}_{(c)}$ = 25 particles
- 16 / 14 / 12

ISO 4406 Cleanliness Code System

Microscope counting examines the particles differently to Contamination Monitoring Products (CMP) and the code is given with two scale numbers only. These are at 5 μm and 15 μm equivalent to the 6 $\mu\text{m}_{(c)}$ and 14 $\mu\text{m}_{(c)}$ of Contamination Monitoring Products (CMP).

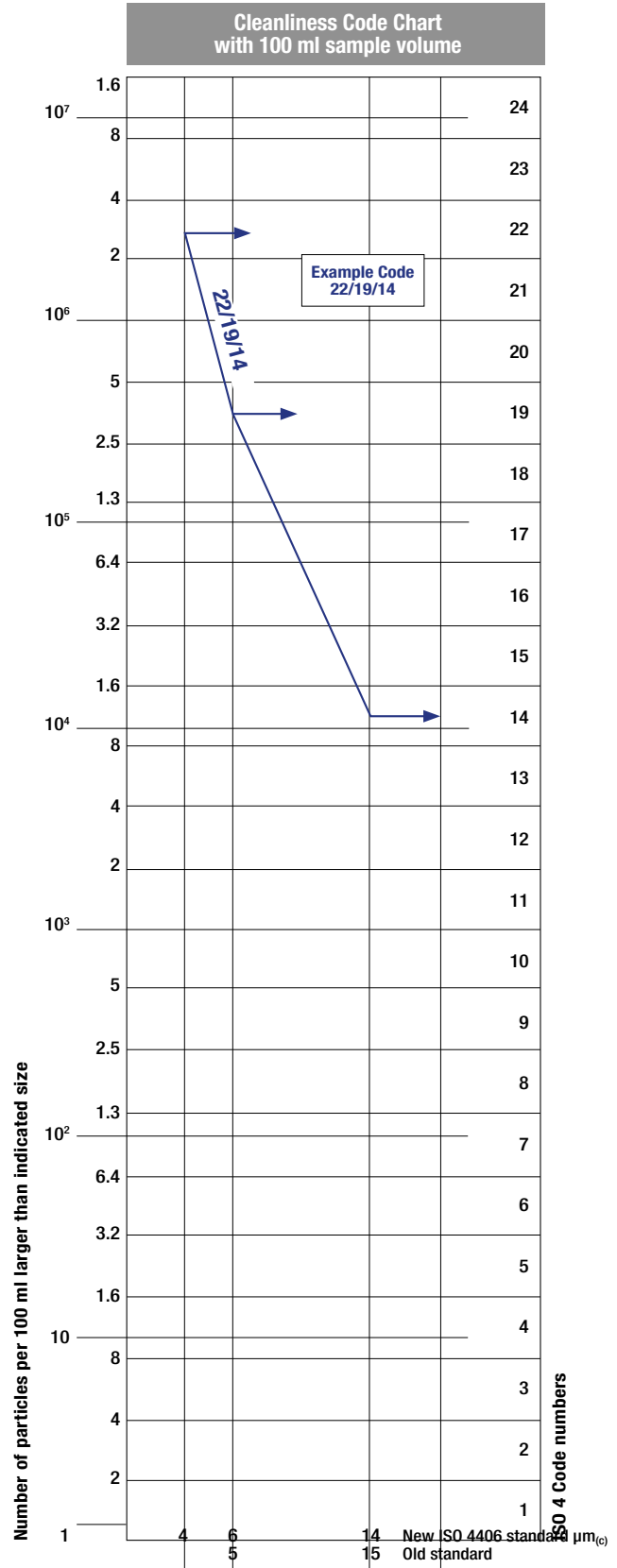

- CUMULATIVE DISTRIBUTION OF THE PARTICLES SIZE
SAE AS4059-1 and SAE AS4059-2

Classification example according to SAE AS4059 - Rev. G

The code, prepared for the aerospace industry, is based on the size, quantity, and particle spacing in a 100 ml fluid sample. The contamination classes are defined by numeric codes, the size of the contaminant is identified by letters (A-F).

This SAE Aerospace Standard (AS) defines cleanliness levels for particulate contamination of hydraulic fluids and includes methods of reporting data relating to the contamination levels. Tables 1 and 2 below provide differential and cumulative particle counts respectively for counts obtained by an automatic particle counter, e.g. LPA3.

Table 1 - Class for differential measurement

Class	Dimension of contaminant Maximum Contamination Limits per 100 ml (3)				
	5-15 µm	15-25 µm	25-50 µm	50-100 µm	>100 µm (1)
	6-14 µm(c)	14-21 µm(c)	21-38 µm(c)	38-70 µm(c)	>70 µm(c) (2)
00	125	22	4	1	0
0	250	44	8	2	0
1	500	89	16	3	1
2	1 000	178	32	6	1
3	2 000	356	63	11	2
4	4 000	712	126	22	4
5	8 000	1 425	253	45	8
6	16 000	2 850	506	90	16
7	32 000	5 700	1 012	180	32
8	64 000	11 400	2 025	360	64
9	128 000	22 800	4 050	720	128
10	256 000	45 600	8 100	1 440	256
11	512 000	91 200	16 200	2 880	512
12	1 024 000	182 400	32 400	5 760	1 024

6 - 14 µm(c) = 15 000 particles
14 - 21 µm(c) = 2 200 particles
21 - 38 µm(c) = 200 particles
38 - 70 µm(c) = 35 particles
> 70 µm(c) = 3 particles
SAE AS4059 REV G - Class 6

(1) Size range, optical microscope, based on longest dimension as measured per AS598 or ISO 4407. (2) Size range CMP calibrated per ISO 11171 or an optical or electron microscope with image analysis software, based on projected area equivalent diameter. (3) Contamination classes and particle count limits are identical to NAS 1638.

Table 2 - Class for cumulative measurement

Class	Dimension of contaminant Maximum Contamination Limits per 100 ml					
	>1 µm	>5 µm	>15 µm	>25 µm	>50 µm	>100 µm (1)
	>4 µm(c)	>6 µm(c)	>14 µm(c)	>21 µm(c)	>38 µm(c)	>70 µm(c) (2)
000	195	76	14	3	1	0
00	390	152	27	5	1	0
0	780	304	54	10	2	0
1	1 560	609	109	20	4	1
2	3 120	1 217	217	39	7	1
3	6 250	2 432	432	76	13	2
4	12 500	4 864	864	152	26	4
5	25 000	9 731	1 731	306	53	8
6	50 000	19 462	3 462	612	106	16
7	100 000	38 924	6 924	1 224	212	32
8	200 000	77 849	13 849	2 449	424	64
9	400 000	155 698	27 698	4 898	848	128
10	800 000	311 396	55 396	9 796	1 696	256
11	1 600 000	622 792	110 792	19 592	3 392	512
12	3 200 000	1 245 584	221 584	39 184	6 784	1 024

> 4 µm(c) = 45 000 particles
> 6 µm(c) = 15 000 particles
> 14 µm(c) = 1 500 particles
> 21 µm(c) = 250 particles
> 38 µm(c) = 15 particles
> 70 µm(c) = 3 particle
SAE AS4059 REV G cpc* Class 6 6/6/5/5/4/2

(1) Size range, optical microscope, based on longest dimension as measured per AS598 or ISO 4407. (2) Size range, CMP calibrated per ISO 11171 or an optical or electron microscope with image analysis software, based on projected area equivalent diameter. (3) Contamination classes and particle count limits are identical to NAS 1638.

* cumulative particle count

- CLASSES OF CONTAMINATION ACCORDING TO NAS 1638 (January 1964)

The NAS system was originally developed in 1964 to define contamination classes for the contamination contained within aircraft components.

The application of this standard was extended to industrial hydraulic systems simply because nothing else existed at the time.

The coding system defines the maximum numbers permitted of 100 ml volume at various size intervals (differential counts) rather than using cumulative counts as in ISO 4406. Although there is no guidance given in the standard on how to quote the levels, most industrial users quote a single code which is the highest recorded in all sizes and this convention is used on MP Filtri Contamination Monitoring Products (CMP).

The contamination classes are defined by a number (from 00 to 12) which indicates the maximum number of particles per 100 ml, counted on a differential basis, in a given size bracket.

Size Range Classes (in microns)

Class	Maximum Contamination Limits per 100 ml				
	5-15	15-25	25-50	50-100	>100
	5-15 µm	15-25 µm	25-50 µm	50-100 µm	>100 µm
00	125	22	4	1	0
0	250	44	8	2	0
1	500	89	16	3	1
2	1 000	178	32	6	1
3	2 000	356	63	11	2
4	4 000	712	126	22	4
5	8 000	1 425	253	45	8
6	16 000	2 850	506	90	16
7	32 000	5 700	1 012	180	32
8	64 000	11 400	2 025	360	64
9	128 000	22 800	4 050	720	128
10	256 000	45 600	8 100	1 440	256
11	512 000	91 200	16 200	2 880	512
12	1 024 000	182 400	32 400	5 760	1 024

5-15 µm = 42 000 particles
15-25 µm = 2 200 particles
25-50 µm = 150 particles
50-100 µm = 18 particles
> 100 µm = 3 particles
Class NAS 8

- CUMULATIVE DISTRIBUTION OF THE PARTICLES SIZE - ISO 4407

The level of contamination is defined by counting the number of particles collected by a laboratory membrane per unit of fluid volume. The measurement is done by a microscope. The membrane must be cleaned, dried and desiccated, with fluid and conditions defined by the Standard. The fluid volume is filtered through the membrane, using a suitable suction system.

The level of contamination is identified by dividing the membrane into a predefined number of areas and by counting the contaminant particles using a suitable laboratory microscope.

MICROSCOPE CONTROL AND MEASUREMENT



Example figure 1 and 2

COMPARISON PHOTOGRAPHS
1 graduation = 10µm



Fig. 1



Fig. 2

For other comparison photographs for contamination classes see the "Fluid Condition and Filtration Handbook".

CONTAMINATION MANAGEMENT

- CLEANLINESS CODE COMPARISON

Although ISO 4406 standard is being used extensively within the hydraulics industry other standards are occasionally required and a comparison may be requested. The table below gives a very general comparison but often no direct comparison is possible due to the different classes and sizes involved.

ISO 4406	SAE AS4059 Table 2	SAE AS4059 Table 1	NAS 1638
> 4 $\mu\text{m}_{(c)}$ 6 $\mu\text{m}_{(c)}$ 14 $\mu\text{m}_{(c)}$	> 4 $\mu\text{m}_{(c)}$ 6 $\mu\text{m}_{(c)}$ 14 $\mu\text{m}_{(c)}$	4-6 6-14 14-21 21-38 38-70 >70	5-15 15-25 25-50 50-100 >100
23 / 21 / 18	13A / 12B / 12C	12	12
22 / 20 / 17	12A / 11B / 11C	11	11
21 / 19 / 16	11A / 10B / 10C	10	10
20 / 18 / 15	10A / 9B / 9B	9	9
19 / 17 / 14	9A / 8B / 8C	8	8
18 / 16 / 13	8A / 7B / 7C	7	7
17 / 15 / 12	7A / 6B / 6C	6	6
16 / 14 / 11	6A / 5B / 5C	5	5
15 / 13 / 10	5A / 4B / 4C	4	4
14 / 12 / 09	4A / 3B / 3C	3	3

6 FILTRATION TECHNOLOGIES

Various mechanisms such as mechanical stoppage, magnetism, gravimetric deposit, or centrifugal separation can be used to reduce the level of contamination.

The mechanical stoppage method is most effective and can take place in two ways:

- SURFACE FILTRATION

It is by direct interception. The filter prevents particles larger than the pores from continuing in the plant / system. Surface filters are generally manufactured with metal canvases or meshes.

- DEPTH FILTERING

Filters are constructed by fiber interlacing. Such wraps form pathways of different shapes and sizes in which the particles remain trapped when they find smaller apertures than their diameter.

Depth filters are generally produced with papers impregnated with phenolic resins, metal fibers or inorganic fibers.

In inorganic fiber filtration, commonly called microfibre, the filtering layers are often overlapped in order to increase the ability to retain the contaminant.

WIRE MESH FILTRATION

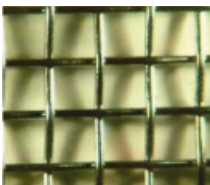

PAPER FILTRATION

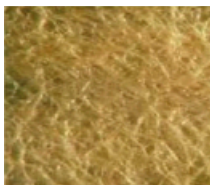

MICROFIBER FILTRATION

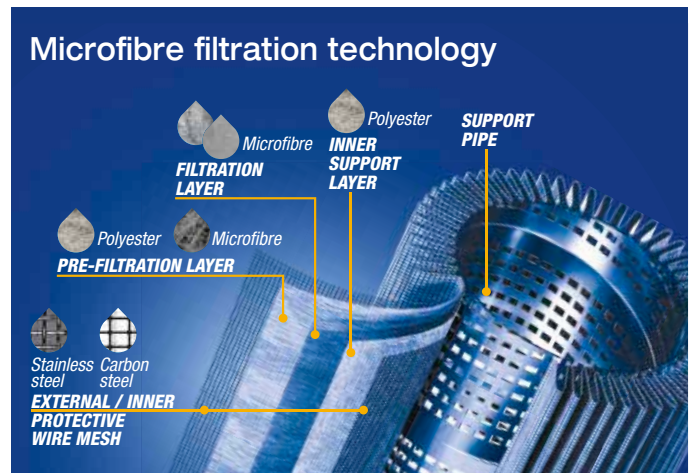
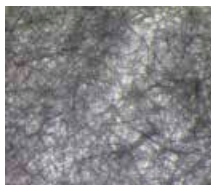

The filtration efficiency of metallic mesh filtrations is defined as the maximum particle size that can pass through the meshes of the filtering grid. The efficiency of microfibre and paper filtration ($\beta_{x(c)}$) is defined through a lab test called Multipass Test. The efficiency value ($\beta_{x(c)}$) is defined as the ratio between the number of particles of certain dimensions detected upstream and downstream of the filter.

$$\frac{\text{Upstream particles number} > X \mu\text{m}_{(c)}}{\text{Downstream particles number} > X \mu\text{m}_{(c)}} = \beta_{x(c)}$$



Value ($\beta_{x(c)}$)	2	10	75	100	200	1000
Efficiency	50%	90%	98.7%	99%	99.5%	99.9%

Test conditions, such as type of fluid to be used (MIL-H-5606), type of contaminant to be used (ISO MTD), fluid viscosity, test temperature, are determined by ISO 16889.

In addition to the filtration efficiency value during the Multipass test, other important features, such as filtration stability (β stability) and dirt holding capacity (DHC), are also tested.

Poor filtration stability is the cause of the filtering quality worsening as the filter life rises. Low dirt holding capacity causes a reduction in the life of the filter.

Filtration ISO Standard Comparison

$\beta_{x(c)} > 1000$ ISO 16889	$\beta_x > 200$ ISO 4572	MP Filtri Filter media code
5 $\mu\text{m}_{(c)}$	3 μm	A03
7 $\mu\text{m}_{(c)}$	6 μm	A06
10 $\mu\text{m}_{(c)}$	10 μm	A10
16 $\mu\text{m}_{(c)}$	18 μm	A16
21 $\mu\text{m}_{(c)}$	25 μm	A25

7 RECOMMENDED CONTAMINATION CLASSES

Any are the nature and the properties of fluids, they are inevitably subject to contamination. The level of contamination can be managed by using special components called filters.

Hydraulic components builders, knowing the problem of contamination, recommend the filtration level appropriate to the use of their products.

Example of recommended contamination levels for pressures below 140 bar.

Piston pumps with fixed flow rate	•					
Piston pumps with variable flow rate			•			
Vane pumps with fixed flow rate		•				
Vane pumps with variable flow			•			
Engines	•					
Hydraulic cylinders	•					
Actuators					•	
Test benches						•
Check valve	•					
Directional valves	•					
Flow regulating valves	•					
Proportional valves				•		
Servo-valves					•	
Flat bearings			•			
Ball bearings				•		
ISO 4406 CODE	20/18/15	19/17/14	18/16/13	17/15/12	16/14/11	15/13/10
Recommended filtration $\beta_{x(c)} \geq 1.000$	$\beta_{21(c)} > 1000$	$\beta_{15(c)} > 1000$	$\beta_{10(c)} > 1000$	$\beta_{7(c)} > 1000$	$\beta_{7(c)} > 1000$	$\beta_{5(c)} > 1000$
MP Filtri media code	A25	A16	A10	A06	A06	A03

The common classification of filters is determined by their position in the plant.

8 TYPES OF FILTERS

Suction filters

They are positioned before the pump and are responsible for protecting the pump from dirty contaminants. It also provides additional flow guidance to the pump suction line.

Being subject to negligible working pressures are manufactured with simple and lightweight construction.

They are mainly produced with gross grade surface filtrations, mainly $60 \div 125 \mu\text{m}$.

They can be equipped with a magnetic filter for retaining ferrous particles.

They are generally placed under the fluid head to take advantage of the piezometric thrust of the fluid and reduce the risk of cavitation.

There are two types of suction filters:

- IMMERSION FILTERS

Simple filter element screwed on the suction pipe

- FILTERS WITH CONTAINER

Container filters that are more bulky, but provide easier maintenance of the tank

Delivery (or Pressure) filters

They are positioned between the pump and most sensitive regulating and controlling components, such as servo valves or proportional valves, and are designed to ensure the class of contamination required by the components used in the circuit.

Being subjected to high working pressures are manufactured with more robust and articulated construction. In particular situations of corrosive environments or aggressive fluids can be made of stainless steel.

They are mainly produced with filtering depths of $3 \div 25 \mu\text{m}$.

They can be manufactured with in-line connections, with plate or flange connections or directly integrated into the circuit control blocks / manifolds.

They can also be manufactured in duplex configuration to allow the contaminated section to be maintained even when the plant / system is in operation without interruption of the working cycle.

Return filters

They are positioned on the return line to the tank and perform the task of filtering the fluid from particles entering the system from the outside or generated by the wear of the components.

They are generally fixed to the reservoir (for this reason also called top tank mounted), positioned semi-immersed or completely immersed.

The positioning of the return filters must guarantee in all operating conditions that the fluid drainage takes place in immersed condition; this is to avoid creating foams in the tank that can cause malfunctions or cavitation in the pumps.

For the sizing of the return filters, account must be taken of the presence of accumulators or cylinders that can make the return flow considerably greater than the pump suction flow rate.

Being subject to contained working pressures are manufactured with simple and lightweight construction.

Normally it is possible to extract the filter element without disconnecting the filter from the rest of the system.

Combined filters

They are designed to be applied to systems with two or more circuits. They are commonly used in hydrostatic transmission machines where they have a dual filtration function of the return line and suction line of the hydrostatic transmission pump.

The filter is equipped with a valve that keeps the 0.5 bar pressure inside the filter. A portion of the fluid that returns to the tank is filtered by the return filter element, generally produced with absolute filtration, and returns to the transmission booster pump.

Only excess fluid returns to the tank through the valve.

The internal pressure of the filter and the absolute filtration help to avoid the cavitation phenomenon inside the pump.

Off-line filters

They are generally used in very large systems / plants, placed in a closed circuit independent from the main circuit. They remain in operation regardless of the operation of the main circuit and are crossed by a constant flow rate.

They can also be manufactured in duplex configuration to allow the contaminated section to be maintained even when the unit is in operation without interruption of the work cycle.

Venting filters

During the operation of the plants, the fluid level present in the reservoir changes continuously.

The result of this continuous fluctuation is an exchange of air with the outside environment.

The venting filter function, positioned on the tank, is to filter the air that enters the tank to compensate for fluid level variations.

9 FILTER SIZING PARAMETERS

The choice of the filter system for an hydraulic system is influenced by several factors.

It is necessary to consider the characteristics of the various components present in the plant and their sensitivity to contamination.

It is also necessary to consider all the tasks that the filter will have to do within the plant:

- FLUID PROTECTION FROM CONTAMINATION
- PROTECTION OF OLEODYNAMIC COMPONENTS SENSITIVE TO CONTAMINATION
- PROTECTION OF OLEODYNAMIC PLANTS FROM ENVIRONMENTAL WASTE
- PROTECTION OF OLEODYNAMIC PLANTS FROM CONTAMINATION CAUSED BY COMPONENTS' FAILURES

The advantages of proper positioning and sizing of the filters are

- MORE RELIABILITY OF THE SYSTEM
- LONGER LIFE OF THE FLUID COMPONENTS
- REDUCTION OF STOP TIME
- REDUCTION OF FAILURE CASUALTIES

Each hydraulic filter is described by general features that identify the possibility of use in different applications.

- **MAXIMUM WORKING PRESSURE (P_{max})**

The maximum working pressure of the filter must be greater than or equal to the pressure of the circuit section in which it will be installed.

- **PRESSURE DROP (ΔP)**

The pressure drop depends on a number of factors, such as the working circuit temperature, the fluid viscosity, the filter element cleaning condition.

- **WORKING TEMPERATURE (T)**

The working temperature deeply affect the choice of materials. Excessively high or low temperatures may adversely affect the strength of the materials or the characteristics of the seals.

- **FILTRATION EFFICIENCY (%) / FILTRATION RATIO ($\beta_{x(c)}$)**

Filtration efficiency is the most important parameter to consider when selecting a filter.

When choosing the filtration performances, the needs of the most sensitive components in the system must be considered.

- **FLUID TYPE**

The type of fluid influences the choice of filters in terms of compatibility and viscosity. It is always mandatory to check the filterability.

- **PLACEMENT IN THE PLANT**

The position of the filter in the system conditions the efficiency of all filter performances.

10 APPLICABLE STANDARDS FOR FILTER DEVELOPMENT

In order to obtain unique criteria for development and verification of the filters performance, specific regulations for the filters and filter elements testing have been issued by ISO. These norms describe the target, the methodology, the conditions and the presentation methods for the test results.

ISO 2941

Hydraulic fluid power -- Filter elements -- Verification of collapse/burst pressure rating

This Standard describes the method for testing the collapse / burst resistance of the filter elements.

The test is performed by crossing the contaminated fluid filter element at a predefined flow rate. The progressive clogging of the filter element, determined by contamination, causes an increase in differential pressure.

ISO 2942

Hydraulic fluid power -- Filter elements -- Verification of fabrication integrity and determination of the first bubble point

This Standard describes the method to verify the integrity of the assembled filter elements.

It can be used to verify the quality of the production process or the quality of the materials by verifying the pressure value of the first bubble point.

ISO 2943

Hydraulic fluid power -- Filter elements -- Verification of material compatibility with fluids

This Standard describes the method to verify the compatibility of materials with certain hydraulic fluids.

The test is carried out by keeping the element (the material sample) immersed in the fluid under high or low temperature conditions for a given period of time and verifying the retention of the characteristics.

ISO 3723

Hydraulic fluid power -- Filter elements -- Method for end load test

This Standard describes the method for verifying the axial load resistance of the filter elements.

After performing the procedure described in ISO 2943, the designed axial load is applied to the filter element. To verify the test results, then the test described in ISO 2941 is performed.

ISO 3968

Hydraulic fluid power -- Filters -- Evaluation of differential pressure versus flow characteristics

This Standard describes the method for checking the pressure drop across the filter.

The test is carried out by crossing the filter from a given fluid and by detecting upstream and downstream pressures.

Some of the parameters defined by the Standard are the fluid, the test temperature, the size of the tubes, the position of the pressure detection points.

ISO 16889

Hydraulic fluid power -- Filters -- Multi-pass method for evaluating filtration performance of a filter element

This Standard describes the method to check the filtration characteristics of the filter elements.

The test is performed by constant introduction of contaminant (ISO MTD). The characteristics observed during the test are the filtration efficiency and the dirty holding capacity related to the differential pressure.

ISO 23181

Hydraulic fluid power -- Filter elements -- Determination of resistance to flow fatigue using high viscosity fluid

This Standard describes the method for testing the fatigue resistance of the filter elements. The test is carried out by subjecting the filter to continuous flow variations, thus differential pressure, using a high viscosity fluid.

ISO 11170

Hydraulic fluid power -- Sequence of tests for verifying performance characteristics of filter elements

The Standard describes the method for testing the performance of filter elements. The protocol described by the regulations provides the sequence of all the tests described above in order to verify all the working characteristics (mechanical, hydraulic and filtration).

ISO 10771-1

Hydraulic fluid power -- Fatigue pressure testing of metal pressure-containing envelopes -- Test method

This Standard describes the method to check the resistance of the hydraulic components with pulsing pressure.

It can be applied to all metal components (excluding tubes) subject to cyclic pressure used in the hydraulic field.

11 WATER IN HYDRAULIC AND LUBRICATING FLUIDS

Water Content

In mineral oils and non aqueous resistant fluids water is undesirable. Mineral oil usually has a water content of 50-300 ppm (@40°C) which it can support without adverse consequences.

Once the water content exceeds about 300ppm the oil starts to appear hazy. Above this level there is a danger of free water accumulating in the system in areas of low flow. This can lead to corrosion and accelerated wear.

Similarly, fire resistant fluids have a natural water which may be different to mineral oil.

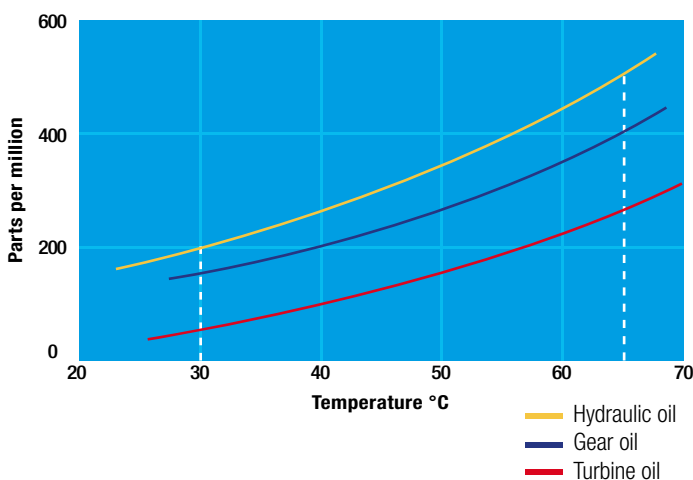

Saturation Levels

Since the effects of free (also emulsified) water is more harmful than those of dissolved water, water levels should remain well below the saturation point.

However, even water in solution can cause damage and therefore every reasonable effort should be made to keep saturation levels as low as possible. There is no such thing as too little water. As a guideline, we recommend maintaining saturation levels below 50% in all equipment.

TYPICAL WATER SATURATION LEVEL FOR NEW OILS

Examples:

Hydraulic oil @ 30°C = 200 ppm = 100% saturation

Hydraulic oil @ 65°C = 500 ppm = 100% saturation

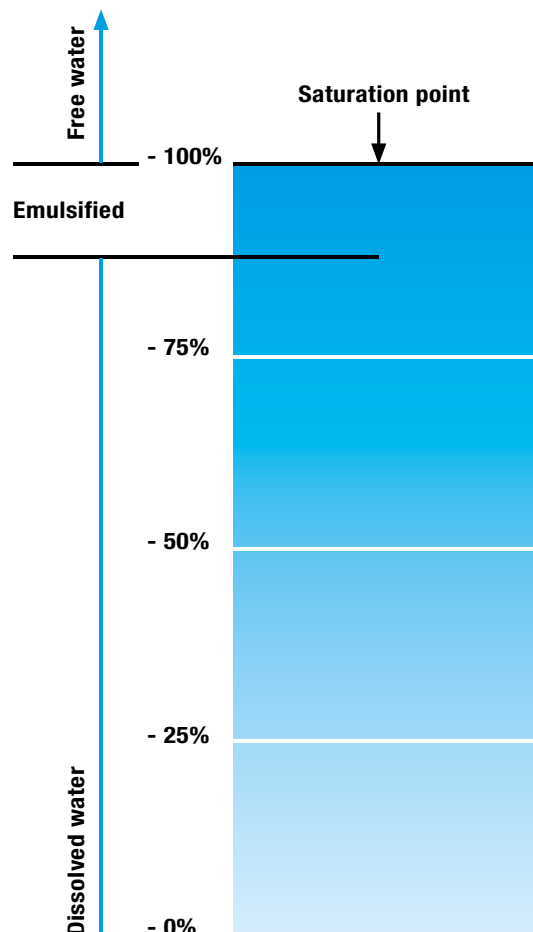

WATER REMOVAL

Water is present everywhere, during storage, handling and servicing.

MP Filtri filter elements feature an absorbent media which protects hydraulic systems from both particulate and water contamination.

MP Filtri's filter element technology is available with inorganic microfiber media with a filtration rating 25 µm (therefore identified with media designation WA025), providing absolute filtration of solid particles to $\beta_{x(c)} = 1000$.

Absorbent media is made by water absorbent fibres which increase in size during the absorption process.

Free water is thus bonded to the filter media and completely removed from the system (it cannot even be squeezed out).

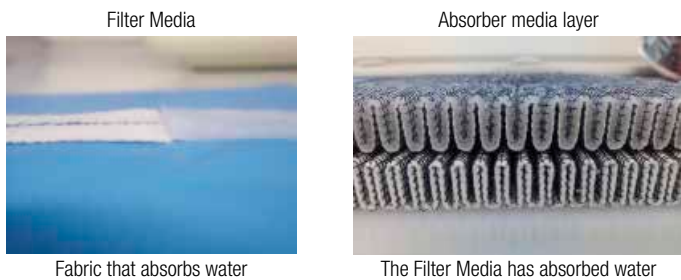

Fabric that absorbs water

The Filter Media has absorbed water

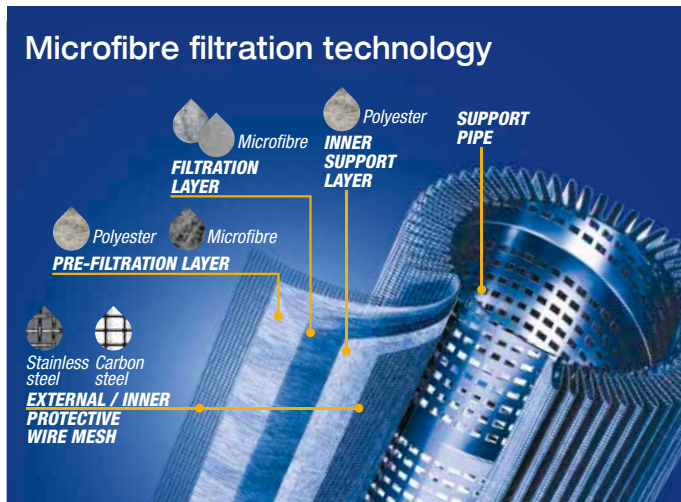

By removing water from your fluid power system, you can prevent such key problems as:

- corrosion (metal etching)
- loss of lubricant power
- accelerated abrasive wear in hydraulic components
- valve-locking
- bearing fatigue
- viscosity variance (reduction in lubricating properties)
- additive precipitation and oil oxidation
- increase in acidity level
- increased electrical conductivity (loss of dielectric strength)
- slow/weak response of control systems

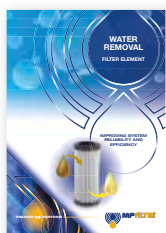

For more details please refer to our dedicate brochure "WATER REMOVAL"



12 THE ANTI-STATIC FILTERS



zerospark is a specialist solution designed to solve the problem of electrostatic discharge inside hydraulic filters. Caused by the electrical charge build-up due to the passage of oil through the filters, this can result in damage to filter elements, oils and circuit components. It can even cause fire hazards in environments where flammable materials are present.

THE TRIBOELECTRIC EFFECT

The body with the most electronegativity strips electrons from the other, generating a build-up of a net negative charge on itself. The other body is charged by the same amount but with the opposite sign, giving rise to very high potential differences. These, if not dissipated, can give rise to electrostatic discharges.

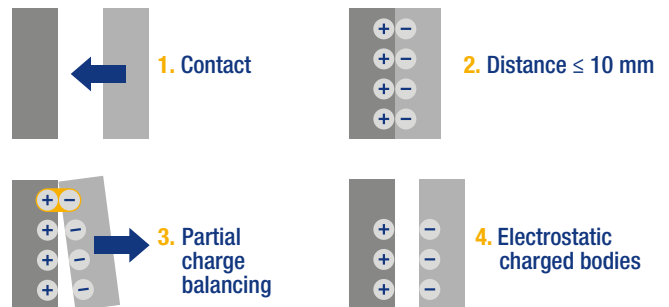

For more details please refer to our dedicate brochure "ZEROSPARK"



FILTER SIZING

INDEX

	Page
CALCULATION	22
CORRECTIVE FACTOR	23

FILTER SIZING Calculation

THE CORRECT FILTER SIZING HAS TO BE BASED ON THE TOTAL PRESSURE DROP DEPENDING ON THE APPLICATION.

FOR EXAMPLE, THE MAXIMUM TOTAL PRESSURE DROP ALLOWED BY A NEW AND CLEAN RETURN FILTER HAS TO BE IN THE RANGE 0.4 - 0.6 bar / 5.80 - 8.70 psi.

The pressure drop calculation is performed by adding together the value of the housing with the value of the filter element. The pressure drop Δp_c of the housing is proportional to the fluid density (kg/dm^3 / lb/ft^3). The filter element pressure drop Δp_e is proportional to its viscosity (mm^2/s / SUS), the corrective factor Y have to be used in case of an oil viscosity different than $30 \text{ mm}^2/\text{s}$ (cSt) / 150 SUS.

Sizing data for single filter element, head at top

Δp_c = Filter housing pressure drop [bar / psi]

Δp_e = Filter element pressure drop [bar / psi]

Y = Corrective factor Y (see correspondent table), depending on the filter type, on the filter element size, on the filter element length and on the filter media

Q = flow rate (l/min - gpm)

V1 reference oil viscosity = $30 \text{ mm}^2/\text{s}$ (cSt) / 150 SUS

V2 = operating oil viscosity in mm^2/s (cSt) / SUS

Filter element pressure drop calculation with an oil viscosity different than $30 \text{ mm}^2/\text{s}$ (cSt) / 150 SUS

International system:

$$\Delta p_e = Y : 1000 \times Q \times (V2:V1)$$

Imperial system:

$$\Delta p_e = Y : 17.2 \times Q \times (V2:V1)$$

$$\Delta p_{\text{Tot.}} = \Delta p_c + \Delta p_e$$

Verification formula

$$\Delta p_{\text{Tot.}} \leq \Delta p_{\text{max allowed}}$$

Maximum total pressure drop (Δp_{max}) allowed by a new and clean filter

Filter family	Δp_{max}	
	[bar]	[psi]
Suction	0.08 bar	1.15 psi
Return	0.50 bar	7.25 psi
Return - Suction (*)	1.50 bar	22.00 psi
Low & Medium Pressure/Duplex	0.70 bar	10.15 psi
High Pressure Pressure/Duplex	1.50 bar	22.00 psi
Stainless Steel	1.50 bar	22.00 psi
ATEX	1.50 bar	22.00 psi

(*)The suction flow rate should not exceed 30% of the return flow rate

Generic filter calculation example

Application data:

Tank top return filter

Pressure Pmax = 10 bar / 145.03 psi

Flow rate Q = 120 l/min / 31.7 gpm

Viscosity V2 = $46 \text{ mm}^2/\text{s}$ (cSt) / 216 SUS

Oil density = $0.86 \text{ kg}/\text{dm}^3$ / $53.68 \text{ lb}/\text{ft}^3$

Required filtration efficiency = 25 μm with absolute filtration

With bypass valve and G 1 1/4" inlet connection

Calculation:

$$\Delta p_c = 0.03 \text{ bar} / 0.43 \text{ psi} \text{ (see graphic below)}$$

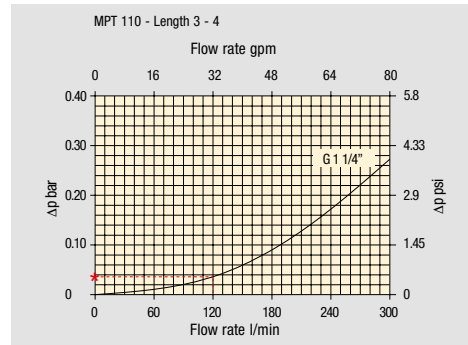

Filter housings Δp pressure drop. The curves are plotted using mineral oil with density of $0.86 \text{ kg}/\text{dm}^3$ in compliance with ISO 3968. Δp varies proportionally with density.

$$\Delta p_e = (2.00 : 1000) \times 120 \times (46 : 30) = 0.37 \text{ bar}$$

$$\Delta p_e = (2.00 : 17.2) \times 32 \times (216 : 150) = 5.36 \text{ psi}$$

Filter element	Absolute filtration H Series					Nominal filtration N Series		
	A03	A06	A10	A16	A25	P(00)10	P(00)25	M(00)25 M(00)60 M(00)90
Return filters	74.00	50.08	20.00	16.00	9.00	6.43	5.51	4.40
MF 020	2 29.20	24.12	8.00	7.22	5.00	3.33	2.85	2.00
	3 22.00	19.00	6.56	5.33	4.33	1.68	1.44	1.30
MF 030	1 74.00	50.08	20.00	16.00	9.00	6.43	5.51	3.40
MFX 030	1 28.20	24.40	8.67	8.17	6.88	4.62	3.96	1.25
MF 100	2 17.33	12.50	6.86	5.70	4.00	3.05	2.47	1.10
MFX 100	3 10.25	9.00	3.65	3.33	2.50	1.63	1.32	0.96
	4 6.10	5.40	2.30	2.20	2.00	1.19	0.96	0.82

$$\Delta p_{\text{Tot.}} = 0.03 + 0.37 = 0.4 \text{ bar}$$

$$\Delta p_{\text{Tot.}} = 0.43 + 5.36 = 5.79 \text{ psi}$$

The selection is correct because the total pressure drop value is inside the admissible range for top tank return filters.

In case the allowed max total pressure drop is not verified, it is necessary to repeat the calculation changing the filter length/size.

SUCTION FILTERS

Filter element		Nominal filtration Collapse ΔP : A = 1 bar					
Type	Length	P10	P25	M25	M60	M90	M250
SF 250	1	78.00	48.00	28.00	24.00	9.33	9.33
SF 503	2	25.88	20.88	10.44	10.00	3.78	3.78
SF 504	3	15.20	14.53	5.14	4.95	2.00	2.00
SF 505	4	3.25	2.55	1.55	1.35	0.71	0.71
SF 510	5	1.96	1.68	0.85	0.72	0.24	0.24
SF 535	2	1.06	0.84	0.42	0.33	0.17	0.17
SF 540	4	1.06	0.84	0.42	0.33	0.17	0.17
FEX 060	-	4.58	3.22	1.02	0.89	0.63	0.63
FEX 080	-	1.97	1.38	0.62	0.45	0.29	0.29
FEX 110	-	1.33	1.12	0.22	0.18	0.14	0.14
FEX 160	-	0.90	0,76	0.15	0.10	0.09	0.09

RETURN FILTERS

Filter element		Absolute filtration H Series					Nominal filtration N Series		
Type	Length	A03	A06	A10	A16	A25	P10	P25	M25 - M60 - M90
MF 020	1	74.00	50.08	20.00	16.00	9.00	6.43	5.51	4.40
	2	29.20	24.12	8.00	7.22	5.00	3.33	2.85	2.00
	3	22.00	19.00	6.56	5.33	4.33	1.68	1.44	1.30
MF 030 MFX 030	1	74.00	50.08	20.00	16.00	9.00	6.43	5.51	3.40
MF 100 MFX 100	1	28.20	24.40	8.67	8.17	6.88	4.62	3.96	1.25
	2	17.33	12.50	6.86	5.70	4.00	3.05	2.47	1.10
	3	10.25	9.00	3.65	3.33	2.50	1.63	1.32	0.96
	4	6.10	5.40	2.30	2.20	2.00	1.19	0.96	0.82
MF 180 MFX 180	1	3.67	3.05	1.64	1.56	1.24	1.18	1.06	0.26
	2	1.69	1.37	0.68	0.54	0.51	0.43	0.39	0.12
MF 190 MFX 190	2	1.69	1.37	0.60	0.49	0.44	0.35	0.31	0.11
MF 400 MFX 400	1	3.20	2.75	1.39	1.33	1.06	0.96	0.87	0.22
	2	2.00	1.87	0.88	0.85	0.55	0.49	0.45	0.13
	3	1.90	1.60	0.63	0.51	0.49	0.39	0.35	0.11
MF 750 MFX 750	1	1.08	0.84	0.49	0.36	0.26	0.21	0.19	0.06
MLX 250	2	3.00	3.04	1.46	1.25	1.17	-	-	M25 0.20
MLX 660	2	1.29	1.26	0.52	0.44	0.38	-	-	M25 0.10
CU 025		78.00	48.00	28.00	24.00	9.33	9.33	8.51	1.25
CU 040		25.88	20.88	10.44	10.00	3.78	3.78	3.30	1.25
CU 100		15.20	14.53	5.14	4.95	2.00	2.00	0.17	1.10
CU 250		3.25	2.55	1.55	1.35	0.71	0.71	0.59	0.25
CU 630		1.96	1.68	0.85	0.72	0.24	0.42	0.36	0.09
CU 850		1.06	0.84	0.42	0.33	0.17	0.17	0.13	0.04

TO BE CONTINUED >>

Corrective factor Y to be used for the filter element pressure drop calculation. The values depend to the filter size and length and to the filter media.
Reference oil viscosity 30 mm²/s

FILTER SIZING Corrective factor

RETURN FILTERS

Filter element		Absolute filtration H Series					Nominal filtration N Series			
Type	Length	A03	A06	A10	A16	A25	P10	P25	M25 - M60 - M90	
MR 250	2	3.61	4.08	1.81	1.71	1.35	-	-	M25 0.55	
	4	2.10	1.70	1.14	0.77	0.53	-	-	0.60	
MR 100	1	19.00	17.00	6.90	6.30	4.60	2.94	2.52	1.60	
	2	11.70	10.80	4.40	4.30	3.00	2.94	2.52	1.37	
	3	7.80	6.87	3.70	3.10	2.70	2.14	1.84	1.34	
	4	5.50	4.97	2.60	2.40	2.18	1.72	1.47	1.34	
	5	4.20	3.84	2.36	2.15	1.90	1.60	1.37	1.34	
MR 250	1	5.35	4.85	2.32	1.92	1.50	1.38	1.20	0.15	
	2	4.00	3.28	1.44	1.10	1.07	0.96	0.83	0.13	
	3	2.60	2.20	1.08	1.00	0.86	0.77	0.64	0.12	
	4	1.84	1.56	0.68	0.56	0.44	0.37	0.23	0.11	
MR 630	1	3.10	2.48	1.32	1.14	0.92	0.83	0.73	0.09	
	2	2.06	1.92	0.82	0.76	0.38	0.33	0.27	0.08	
	3	1.48	1.30	0.60	0.56	0.26	0.22	0.17	0.08	
	4	1.30	1.20	0.48	0.40	0.25	0.21	0.16	0.08	
	5	0.74	0.65	0.30	0.28	0.13	0.10	0.08	0.04	
MR 850	1	0.60	0.43	0.34	0.25	0.13	0.12	0.09	0.03	
	2	0.37	0.26	0.23	0.21	0.11	0.08	0.07	0.03	
	3	0.27	0.18	0.17	0.17	0.05	0.04	0.04	0.02	
	4	0.23	0.16	0.13	0.12	0.04	0.03	0.03	0.02	

RETURN / SUCTION FILTERS

Filter element		Absolute filtration		
Type	Length	A10	A16	A25
RSX 116	1	5.12	4.33	3.85
	2	2.22	1.87	1.22
RSX 165 RSX 166	1	2.06	1.75	1.46
	2	1.24	1.05	0.96
	3	0.94	0.86	0.61

Filter element		Absolute filtration N Series							
Type	Length	A03	A06	A10	A16	A25	P10	P25	M25 - M60 - M90
CU 110	1	16.25	15.16	8.75	8.14	5.87	2.86	2.65	0.14
	2	12.62	10.44	6.11	6.02	4.16	1.60	1.49	0.12
	3	8.57	7.95	5.07	4.07	2.40	1.24	1.15	0.11
	4	5.76	4.05	4.05	2.36	1.14	0.91	0.85	0.05

Corrective factor Y to be used for the filter element pressure drop calculation. The values depend to the filter size and length and to the filter media.
Reference oil viscosity 30 mm²/s

LOW & MEDIUM PRESSURE FILTERS

Filter element		Absolute filtration N - W Series					Nominal filtration N Series		
Type	Length	A03	A06	A10	A16	A25	P10	P25	M25
CU 110	1	16.25	15.16	8.75	8.14	5.87	2.86	2.65	0.14
	2	12.62	10.44	6.11	6.02	4.15	1.60	1.49	0.12
	3	8.57	7.95	5.07	4.07	2.40	1.24	1.15	0.11
	4	5.76	4.05	2.80	2.36	1.14	0.91	0.85	0.05
CU 210	1	5.30	4.80	2.00	1.66	1.32	0.56	0.43	0.12
	2	3.44	2.95	1.24	1.09	0.70	0.42	0.35	0.09
	3	2.40	1.70	0.94	0.84	0.54	0.33	0.23	0.05
DN	016	7.95	7.20	3.00	2.49	1.98	0.84	0.65	0.18
	025	5.00	4.53	1.89	1.57	1.25	0.53	0.41	0.11
	040	3.13	2.66	1.12	0.98	0.63	0.38	0.32	0.08
CU 400	2	3.14	2.55	1.46	1.22	0.78	0.75	0.64	0.19
	3	2.15	1.70	0.94	0.78	0.50	0.40	0.34	0.10
	4	1.60	1.28	0.71	0.61	0.40	0.34	0.27	0.08
	5	1.00	0.83	0.47	0.34	0.20	0.24	0.19	0.06
	6	0.82	0.58	0.30	0.27	0.17	0.22	0.18	0.105
CU 900	1	0.86	0.63	0.32	0.30	0.21	-	-	0.05
CU 950	2	1.03	0.80	0.59	0.40	0.26	-	-	0.05
	3	0.44	0.40	0.27	0.18	0.15	-	-	0.02
MR 630	7	0.88	0.78	0.36	0.34	0.16	0.12	0.96	0.47

HIGH PRESSURE FILTERS

Filter element		Absolute filtration N - R Series					Nominal filtration N Series
Type	Length	A03	A06	A10	A16	A25	M25
HP 010 HP 011	1	332.71	250.07	184.32	152.36	128.36	-
	2	220.28	165.56	74.08	59.13	37.05	-
	3	123.24	92.68	41.48	33.08	20.72	-
	4	77.76	58.52	28.37	22.67	16.17	-
HP 039	2	70.66	53.20	25.77	20.57	14.67	4.90
	3	36.57	32.28	18.00	13.38	8.00	2.90
	4	26.57	23.27	12.46	8.80	5.58	2.20
HP 050 HPX 050	1	31.75	30.30	13.16	12.3	7.29	1.60
	2	24.25	21.26	11.70	9.09	4.90	1.40
	3	17.37	16.25	8.90	7.18	3.63	1.25
	4	12.12	10.75	6.10	5.75	3.08	1.07
	5	7.00	6.56	3.60	3.10	2.25	0.80
HP 065	1	58.50	43.46	23.16	19.66	10.71	1.28
	2	42.60	25.64	16.22	13.88	7.32	1.11
	3	20.50	15.88	8.18	6.81	3.91	0.58
HP 135	1	20.33	18.80	9.71	8.66	4.78	2.78
	2	11.14	10.16	6.60	6.38	2.22	1.11
	3	6.48	6.33	3.38	3.16	2.14	1.01
HP 150	1	17.53	15.91	7.48	6.96	5.94	1.07
	2	8.60	8.37	3.54	3.38	3.15	0.58
	3	6.53	5.90	2.93	2.79	2.12	0.49

TO BE CONTINUED >>

Corrective factor Y to be used for the filter element pressure drop calculation. The values depend to the filter size and length and to the filter media.
Reference oil viscosity 30 mm²/s

FILTER SIZING Corrective factor

HIGH PRESSURE FILTERS

Filter element		Absolute filtration N - R Series					Nominal filtration N Series
Type	Length	A03	A06	A10	A16	A25	M25
HP 320	1	10.88	9.73	5.02	3.73	2.54	1.04
	2	4.40	3.83	1.75	1.48	0.88	0.71
	3	2.75	2.11	1.05	0.87	0.77	0.61
	4	2.12	1.77	0.98	0.78	0.55	0.47
HP 500	1	4.44	3.67	2.30	2.10	1.65	0.15
	2	3.37	2.77	1.78	1.68	1.24	0.10
	3	2.22	1.98	1.11	1.09	0.75	0.08
	4	1.81	1.33	0.93	0.86	0.68	0.05
	5	1.33	1.15	0.77	0.68	0.48	0.04
HP 325	1	3.65	2.95	2.80	1.80	0.90	0.38
	2	2.03	1.73	1.61	1.35	0.85	0.36
	3	1.84	1.42	1.32	1.22	0.80	0.35

Filter element		Absolute filtration S - H - U Series				
Type	Length	A03	A06	A10	A16	A25
HP 010 HP 011	1	424.58	319.74	235.17	194.44	163.78
	2	281.06	211.25	94.35	75.45	47.26
	3	130.14	97.50	43.63	34.82	21.81
	4	109.39	82.25	36.79	29.37	18.40
HP 039	2	73.00	57.00	28.00	24.00	17.20
	3	40.90	36.33	21.88	18.80	11.20
	4	31.50	28.22	17.22	9.30	6.70
HP 050 HPX 050	1	47.33	34.25	21.50	20.50	14.71
	2	29.10	25.95	10.04	10.90	5.88
	3	20.85	19.50	10.68	8.61	4.36
	4	14.55	12.90	7.32	6.90	3.69
	5	9.86	9.34	6.40	4.80	2.50
HP 135	1	29.16	25.33	13.00	12.47	5.92
	2	14.28	11.04	7.86	7.90	4.44
	3	8.96	7.46	4.89	4.16	3.07
HP 320	1	13.00	12.19	6.80	6.40	3.32
	2	6.45	5.31	3.01	2.89	1.73
	3	4.13	3.14	1.90	1.78	1.17
	4	3.17	2.71	1.80	1.70	1.10
HP 500	1	9.70	8.81	4.55	4.47	2.80
	2	5.46	4.63	2.88	2.68	2.20
	3	3.90	3.74	2.22	2.07	1.53
	4	3.10	2.84	1.56	1.53	1.02
	5	1.93	1.83	1.14	1.08	0.69

Corrective factor Y to be used for the filter element pressure drop calculation. The values depend to the filter size and length and to the filter media.
Reference oil viscosity 30 mm²/s

STAINLESS STEEL HIGH PRESSURE FILTERS

Filter element		Absolute filtration N - R Series					Nominal filtration N Series
Type	Length	A03	A06	A10	A16	A25	M25
HP 010 HP 011	1	332.71	250.07	184.32	152.36	128.36	-
	2	220.28	165.56	74.08	59.13	37.05	-
	3	123.24	92.68	41.48	33.08	20.72	-
	4	77.76	58.52	28.37	22.67	16.17	-
HP 039	2	70.66	53.20	25.77	20.57	14.67	4.90
	3	36.57	32.28	18.00	13.38	8.00	2.90
	4	26.57	23.27	12.46	8.80	5.58	2.20
HP 050	1	31.75	30.30	13.16	12.3	7.29	1.60
	2	24.25	21.26	11.70	9.09	4.90	1.40
	3	17.37	16.25	8.90	7.18	3.63	1.25
	4	12.12	10.75	6.10	5.75	3.08	1.07
	5	7.00	6.56	3.60	3.10	2.25	0.80
HP 135	1	20.33	18.80	9.71	8.66	4.78	2.78
	2	11.14	10.16	6.60	6.38	2.22	1.11
	3	6.48	6.33	3.38	3.16	2.14	1.01

Filter element		Absolute filtration S - H - U Series				
Type	Length	A03	A06	A10	A16	A25
HP 010 HP 011	1	424.58	319.74	235.17	194.44	163.78
	2	281.06	211.25	94.35	75.45	47.26
	3	130.14	97.50	43.63	34.82	21.81
	4	109.39	82.25	36.79	29.37	18.40
HP 039	2	73.00	57.00	28.00	24.00	17.20
	3	40.90	36.33	21.88	18.80	11.20
	4	31.50	28.22	17.22	9.30	6.70
HP 050	1	47.33	34.25	21.50	20.50	14.71
	2	29.10	25.95	10.04	10.90	5.88
	3	20.85	19.50	10.68	8.61	4.36
	4	14.55	12.90	7.32	6.90	3.69
	5	9.86	9.34	6.40	4.80	2.50
HP 135	1	29.16	25.33	13.00	12.47	5.92
	2	14.28	11.04	7.86	7.90	4.44
	3	8.96	7.46	4.89	4.16	3.07

Corrective factor Y to be used for the filter element pressure drop calculation. The values depend to the filter size and length and to the filter media.
Reference oil viscosity 30 mm²/s

FILTER SIZING Corrective factor

FILTERS FOR POTENTIALLY EXPLOSIVE ATMOSPHERE

Filter element		Absolute filtration N - R Series					Nominal filtration N Series
Type	Length	A03	A06	A10	A16	A25	M25
HP 010 HP 011	1	332.71	250.07	184.32	152.36	128.36	-
	2	220.28	165.56	74.08	59.13	37.05	-
	3	123.24	92.68	41.48	33.08	20.72	-
	4	77.76	58.52	28.37	22.67	16.17	-
HP 039	2	70.66	53.20	25.77	20.57	14.67	4.90
	3	36.57	32.28	18.00	13.38	8.00	2.90
	4	26.57	23.27	12.46	8.80	5.58	2.20
HPX 050	1	31.75	30.30	13.16	12.3	7.29	1.60
	2	24.25	21.26	11.70	9.09	4.90	1.40
	3	17.37	16.25	8.90	7.18	3.63	1.25
	4	12.12	10.75	6.10	5.75	3.08	1.07
	5	7.00	6.56	3.60	3.10	2.25	0.80
HP 135	1	20.33	18.80	9.71	8.66	4.78	2.78
	2	11.14	10.16	6.60	6.38	2.22	1.11
	3	6.48	6.33	3.38	3.16	2.14	1.01

Filter element		Absolute filtration S - H - U Series				
Type	Length	A03	A06	A10	A16	A25
HP 010 HP 011	1	424.58	319.74	235.17	194.44	163.78
	2	281.06	211.25	94.35	75.45	47.26
	3	130.14	97.50	43.63	34.82	21.81
	4	109.39	82.25	36.79	29.37	18.40
HP 039	2	73.00	57.00	28.00	24.00	17.20
	3	40.90	36.33	21.88	18.80	11.20
	4	31.50	28.22	17.22	9.30	6.70
HPX 050	1	47.33	34.25	21.50	20.50	14.71
	2	29.10	25.95	10.04	10.90	5.88
	3	20.85	19.50	10.68	8.61	4.36
	4	14.55	12.90	7.32	6.90	3.69
	5	9.86	9.34	6.40	4.80	2.50
HP 135	1	29.16	25.33	13.00	12.47	5.92
	2	14.28	11.04	7.86	7.90	4.44
	3	8.96	7.46	4.89	4.16	3.07

Corrective factor Y to be used for the filter element pressure drop calculation. The values depend to the filter size and length and to the filter media.

Filters sizing software

The web-based software program will allow you to select the most suitable MP Filtri's Filters, in accordance with your process design requirements.

The program will automatically check your input design process prior to propose you the acceptable solutions and create an output in PDF report style format.

The MP Filtri Selection Tool software program is easy to use with a flexible fast design method and provides improved layout formats with full descriptions.

The web-based tool is available at MP Filtri website at following link:
<https://www.mpfiltri.com/tools/>

The related, complete user guide is available as Manual and downloadable from the "Download" section of MP Filtri website, as well as scanning the following QR code



Spin-On filters are used as process and safety filters to protect individual pumps, valves or the entire hydraulic circuit from contamination as per ISO 4406.

In-line Spin-On filters can be used for the following purposes:

- **Suction filters**
- **On the return circuit, for mounting on the line or on the tank cover**
- **In-line for low and medium pressure applications**

Spin-On filters are available in 4 configurations:

- **Single cartridge in-line**
- **In-line with two parallel cartridges on the same axis**
- **In-line with two parallel cartridges mounted side by side**

All versions may be equipped with visual and/or electrical blockage indicators.

Spin-on filters



MPS	page 295
MSH	311
INDICATORS	714

MPS series

Maximum working pressure up to 1.2 MPa (12 bar) - Flow rate up to 365 l/min



Description

Technical data

Spin-on filters

Maximum working pressure up to 1.2 MPa (12 bar)

Flow rate up to 365 l/min

MPS is a range of spin-on filters suitable to be used in suction, return and low pressure lines.

They offer a good balance between performances, dimensions and prices. They are directly connected to the lines of the system through the hydraulic fittings.

Available features:

- Female threaded connections up to 1 1/2" and flanged connections up to 1 1/2", for a maximum flow rate of 365 l/min
- Fine filtration rating, to get a good cleanliness level into the reservoir
- Water removal elements (CW), to remove the free water from the hydraulic fluid
- Double connection for the cans, to fit both European and American standard elements
- Double cans fitting, to increase the life time of the filter
- Bypass valve, to relieve excessive pressure drop across the filter media
- Visual, electrical and electronic clogging indicators for suction and return applications
- Visual, electrical and electronic differential clogging indicators for low pressure applications

Common applications:

- Suction lines, Return lines, Delivery lines, in economic industrial equipment or mobile machines.
- Off-line filtration tank in economic industrial equipment or mobile machines

Filter housing materials

- Head: Aluminium
- Bypass valve: Polyamide - Steel
- Element: Zinc-Plated Steel - Painted steel

Bypass valve

- Inline / Return filter opening pressure: 175 kPa (1.75 bar) $\pm 10\%$
- Inline / Suction filter opening pressure: 30 kPa (0.3 bar) $\pm 10\%$

Δp element type

- Δp : 5 bar
- Fluid flow through the filter element from OUT to IN

Seals

Standard NBR - series A

Temperature

From -20 °C to +110 °C

Note

MPS filters are provided for vertical mounting

Weights [kg] and volumes [dm³]

Filter series	Weights [kg]	Volumes [dm ³]
MPS 050	1.00	0.70
MPS 051	1.05	0.70
MPS 070	1.20	0.95
MPS 071	1.25	0.95
MPS 100	2.10	1.65
MPS 101	2.20	1.65
MPS 150	2.40	2.00
MPS 151	2.50	2.00
MPS 200	3.90	3.00
MPS 250	4.60	3.70
MPS 300-301	5.30	3.40
MPS 350-351	6.00	4.10

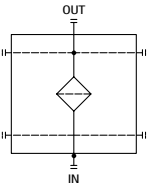
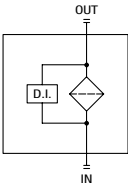
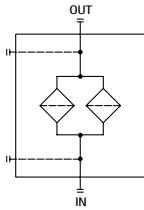
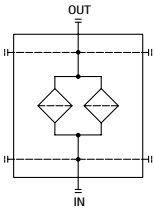
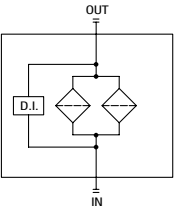
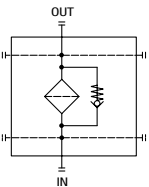
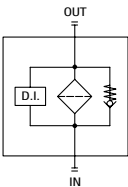
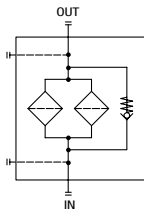
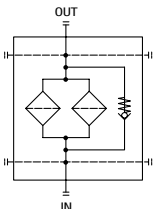
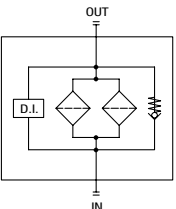
Filter series					
MPS 050	•	-	-	-	-
MPS 051	-	•	-	-	-
MPS 070	•	-	-	-	-
MPS 071	-	•	-	-	-
MPS 100	•	-	-	-	-
MPS 101	-	•	-	-	-
MPS 150	•	-	-	-	-
MPS 151	-	•	-	-	-
MPS 200	-	-	•	-	-
MPS 250	-	-	•	-	-
MPS 300	-	-	-	•	-
MPS 301	-	-	-	-	•
MPS 350	-	-	-	•	-
MPS 351	-	-	-	-	•
	Style U/P	Style U/P	Style U	Style U/P	Style U/P
					
	Style R/S	Style R/S	Style R/S	Style R/S	Style R/S
					

Pressure drop

Bypass valve
pressure drop

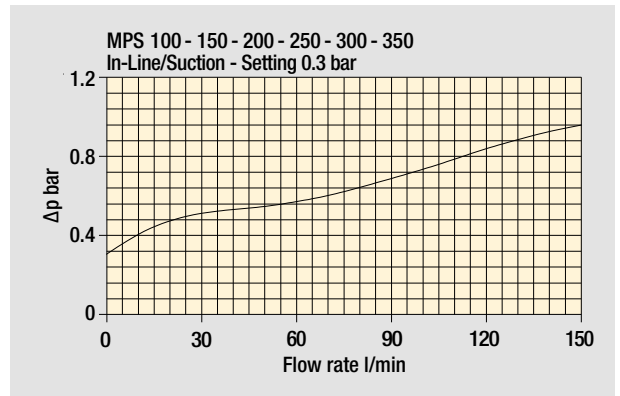
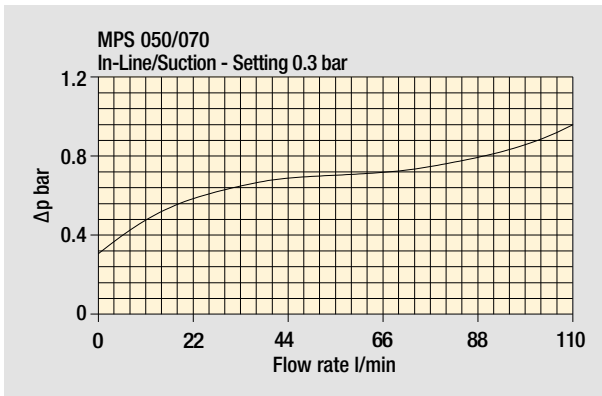
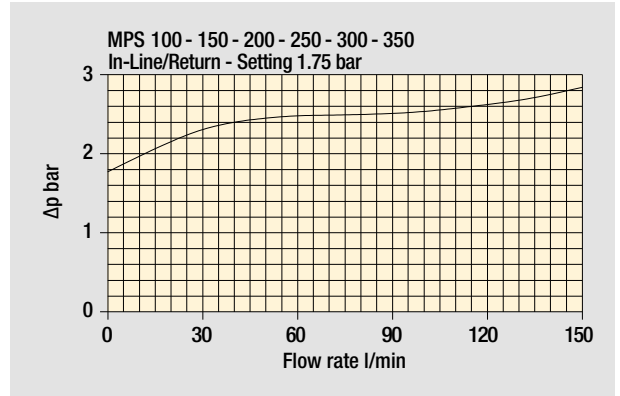
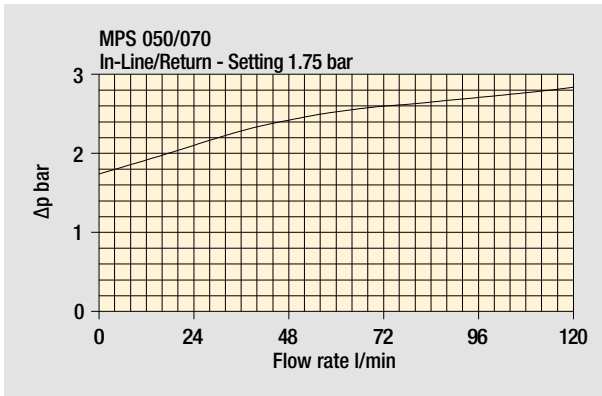

The curves are plotted using mineral oil with density of 0.86 kg/dm³ in compliance with ISO 3968. Δp varies proportionally with density.

CS 050 - 070 - 100 - 150

CG - CW 050 - 070



CG - CW 100 - 150



CW

This series of cartridge removes water from oil while filtering the oil at the same time.

Water absorbent polymers up to 800 times their own weight provide this major feature.

Water holding capacities:

CW 050= 240 ml

Ordering code: **CW050P10AP01**

CW 150= 788 ml

Ordering code: **CW150P10AP01**

Thread connections

Element	Connection
CS 050 - 070	G 3/4"
CS 100 - 150	G 1 1/4"
CG / CW 050 - 070	1" - 12 UNF
CG / CW 100 - 150	1 1/2" - 16 UN

Water holding capacities CW

	good	poor
Viscosity	30/46 mm ² /s (cSt)	> 46 mm ² /s (cSt)
H₂O p.p.m.	600/800 p.p.m.	> 800 p.p.m.
Flow rate	CW050 7/15 l/min CW150 20/40 l/min	CW050 > 20 l/min CW150 > 50 l/min
Temperature	40/60 °C	< 30 °C

Heads

CG / CW
1" - 12 UNF

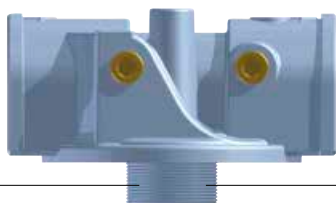

CS
G 3/4"

CG / CW
1 1/2" - 16 UN

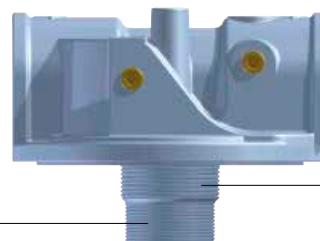

CS
G 1 1/4"

MPS MPS050 - MPS070 MPS051 - MPS071

Designation & Ordering code

COMPLETE FILTER

Series and size		Configuration example: MPS050 R G1 A10 A P01				
MPS050 MPS070	With connections for clogging indicators					
MPS051 MPS071	With connections for differential pressure indicators					
Bypass valve		MPS 050 - 070	MPS 051 - 071			
R	Inline / Return: with bypass 1.75 bar	•	•			
S	Inline / Suction: with bypass 0.3 bar	•	-			
U	Without bypass	•	-			
P	Without bypass	-	•			
Connections						
G1	G 3/4"					
G2	3/4" NPT					
G3	SAE 12 - 1 1/16" - 12 UN					
Filtration rating (filter media)						
A03	Inorganic microfiber 3 µm	M25	Wire mesh 25 µm			
A06	Inorganic microfiber 6 µm	M60	Wire mesh 60 µm			
A10	Inorganic microfiber 10 µm	M90	Wire mesh 90 µm			
A25	Inorganic microfiber 25 µm	P10	Resin impregnated paper 10 µm			
		P25	Resin impregnated paper 25 µm			
		Seal		Execution		
		A NBR		P01 MP Filtri standard		

CARTRIDGE

Cartridge series and size		Configuration example: CS050 A10 A P01			
CS050 CS070					
Filtration rating (filter media)					
A03	Inorganic microfiber 3 µm	M25	Wire mesh 25 µm		
A06	Inorganic microfiber 6 µm	M60	Wire mesh 60 µm		
A10	Inorganic microfiber 10 µm	M90	Wire mesh 90 µm		
A25	Inorganic microfiber 25 µm	P10	Resin impregnated paper 10 µm		
		P25	Resin impregnated paper 25 µm		
		Seals		Execution	
		A NBR		P01 MP Filtri standard Pxx Customized	

CLOGGING INDICATORS

See page 714-715

Clogging indicators on RETURN line

BVA	Axial pressure gauge
BVR	Radial pressure gauge
BVP	Visual pressure indicator with automatic reset
BVQ	Visual pressure indicator with manual reset

BEA	Electrical pressure indicator
BEM	Electrical pressure indicator
BLA	Electrical / visual pressure indicator

Clogging indicators on SUCTION line

VVB	Axial pressure gauge
VVS	Radial pressure gauge

VEB	Electrical vacuum indicator
VLB	Electrical / visual vacuum indicator

Differential pressure indicators

DEA	Electrical differential pressure indicator
DEM	Electrical differential pressure indicator
DEU	Electrical differential pressure indicator
DLA	Electrical / visual differential pressure indicator

DLE	Electrical / visual differential pressure indicator
DTA	Electronic differential pressure indicator
DVA	Visual differential pressure indicator
DVM	Visual differential pressure indicator

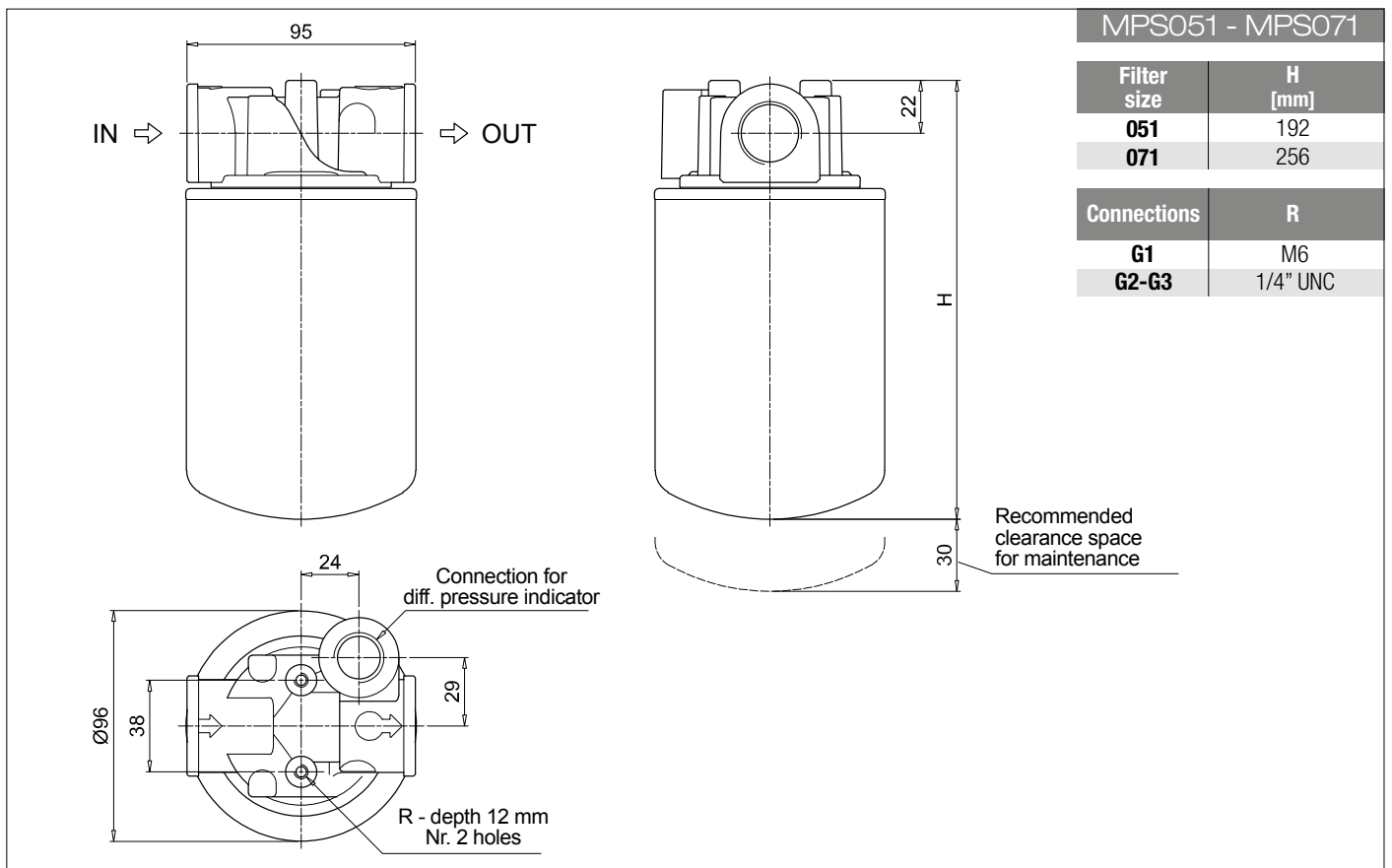
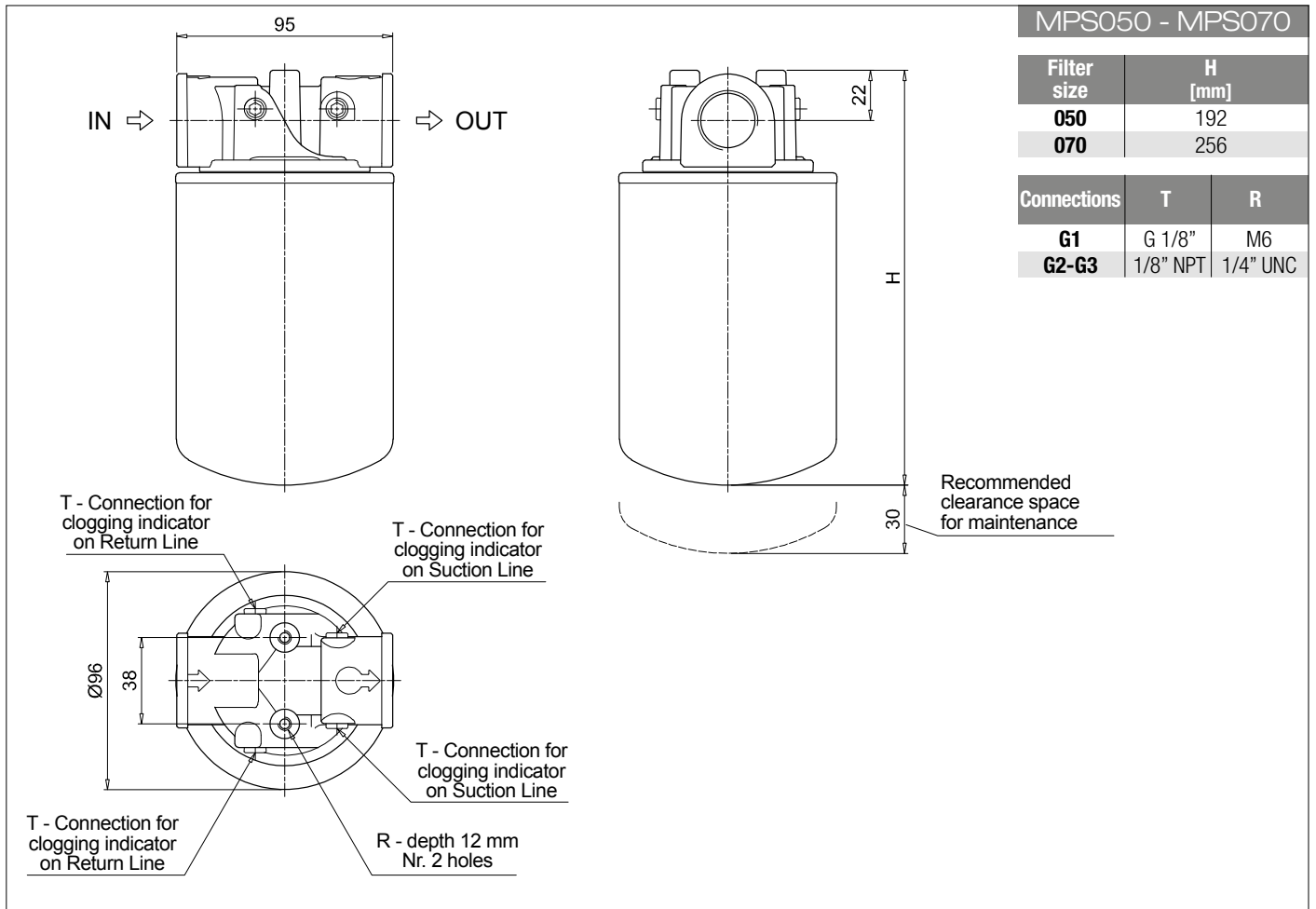

MPS MPS100 - MPS150 MPS101 - MPS151

Designation & Ordering code

COMPLETE FILTER

Series and size		Configuration example: MPS100 R G1 A10 A P01				
MPS100 MPS150	With connections for clogging indicators					
MPS101 MPS151	With connections for differential pressure indicators					
Bypass valve		MPS 100 - 150	MPS 101 - 151			
R	Inline / Return: with bypass 1.75 bar	•	•			
S	Inline / Suction: with bypass 0.3 bar	•	-			
U	Without bypass	•	-			
P	Without bypass	-	•			
Connections						
G1	G 1 1/4"					
G2	1 1/4" NPT					
G3	SAE 20 - 1 5/8" - 12 UN					
Filtration rating (filter media)						
A03	Inorganic microfiber 3 µm	M25	Wire mesh 25 µm			
A06	Inorganic microfiber 6 µm	M60	Wire mesh 60 µm			
A10	Inorganic microfiber 10 µm	M90	Wire mesh 90 µm			
A25	Inorganic microfiber 25 µm	P10	Resin impregnated paper 10 µm			
		P25	Resin impregnated paper 25 µm			
		Seal		Execution		
		A NBR		P01 MP Filtri standard		

CARTRIDGE

Cartridge series and size		Configuration example: CS100 A10 A P01			
CS100 CS150					
Filtration rating (filter media)					
A03	Inorganic microfiber 3 µm	M25	Wire mesh 25 µm		
A06	Inorganic microfiber 6 µm	M60	Wire mesh 60 µm		
A10	Inorganic microfiber 10 µm	M90	Wire mesh 90 µm		
A25	Inorganic microfiber 25 µm	P10	Resin impregnated paper 10 µm		
		P25	Resin impregnated paper 25 µm		
		Seals		Execution	
		A NBR		P01 MP Filtri standard Pxx Customized	

CLOGGING INDICATORS

See page 714-715

Clogging indicators on RETURN line

BVA	Axial pressure gauge
BVR	Radial pressure gauge
BVP	Visual pressure indicator with automatic reset
BVQ	Visual pressure indicator with manual reset

BEA	Electrical pressure indicator
BEM	Electrical pressure indicator
BLA	Electrical / visual pressure indicator

Clogging indicators on SUCTION line

VVB	Axial pressure gauge
VVS	Radial pressure gauge

VEB	Electrical vacuum indicator
VLB	Electrical / visual vacuum indicator

Differential pressure indicators

DEA	Electrical differential pressure indicator
DEM	Electrical differential pressure indicator
DEU	Electrical differential pressure indicator
DLA	Electrical / visual differential pressure indicator

DLE	Electrical / visual differential pressure indicator
DTA	Electronic differential pressure indicator
DVA	Visual differential pressure indicator
DVM	Visual differential pressure indicator

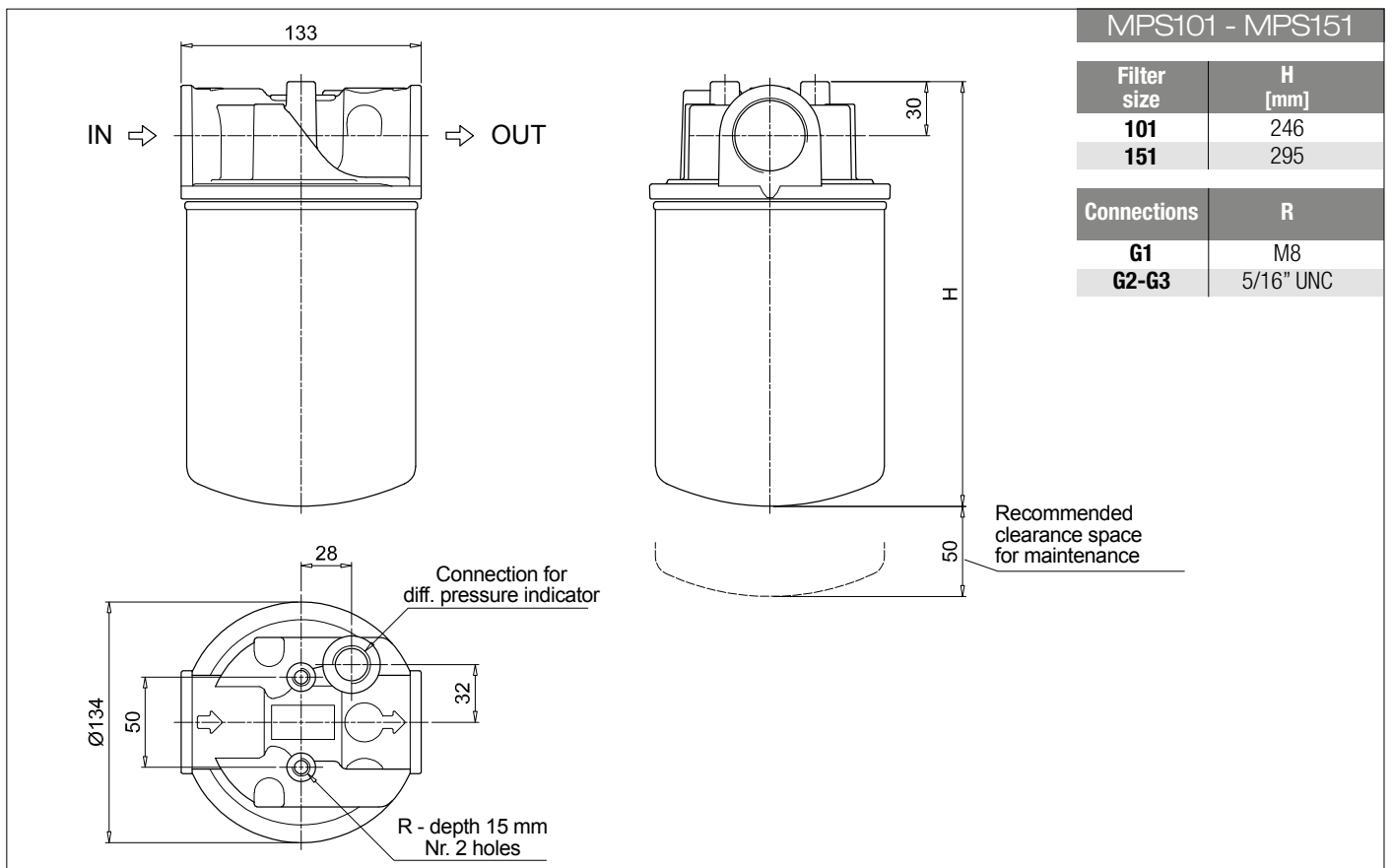
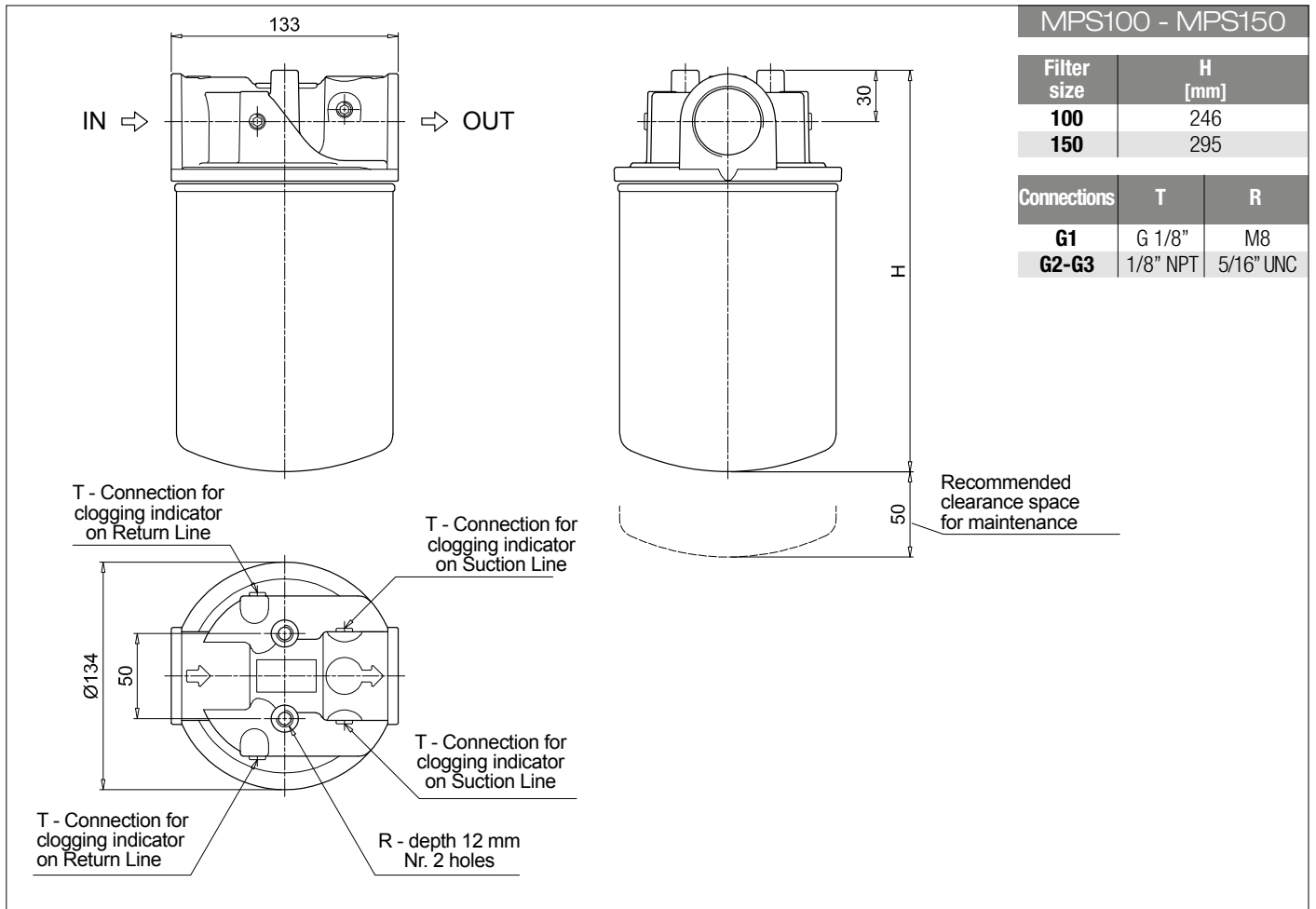

MPS MPS200 - MPS250

Designation & Ordering code

COMPLETE FILTER

Series and size

MPS200 | **MPS250**

Configuration example: **MPS200** **R** **G1** **A10** **A** **P01**

Bypass valve

R Inline / Return: with bypass 1.75 bar

S Inline / Suction: with bypass 0.3 bar

U Without bypass

Connections

G1 G 1 1/2"

G2 1 1/2" NPT

G3 SAE 24 - 1 7/8" - 12 UN

Filtration rating (filter media)

A03 Inorganic microfiber 3 µm

A06 Inorganic microfiber 6 µm

A10 Inorganic microfiber 10 µm

A25 Inorganic microfiber 25 µm

M25 Wire mesh 25 µm

M60 Wire mesh 60 µm

M90 Wire mesh 90 µm

P10 Resin impregnated paper 10 µm

P25 Resin impregnated paper 25 µm

Seal

A NBR

Execution

P01 MP Filtri standard

CARTRIDGE

Cartridge series and size

CS100 | **CS150**

Configuration example: **CS100** **A10** **A** **P01**

Filtration rating (filter media)

A03 Inorganic microfiber 3 µm

A06 Inorganic microfiber 6 µm

A10 Inorganic microfiber 10 µm

A25 Inorganic microfiber 25 µm

M25 Wire mesh 25 µm

M60 Wire mesh 60 µm

M90 Wire mesh 90 µm

P10 Resin impregnated paper 10 µm

P25 Resin impregnated paper 25 µm

Seals

A NBR

Execution

P01 MP Filtri standard

Pxx Customized

CLOGGING INDICATORS

See page 714-715

Clogging indicators on RETURN line

BVA Axial pressure gauge

BVR Radial pressure gauge

BVP Visual pressure indicator with automatic reset

BVQ Visual pressure indicator with manual reset

BEA Electrical pressure indicator

BEM Electrical pressure indicator

BLA Electrical / visual pressure indicator

Clogging indicators on SUCTION line

VVB Axial pressure gauge

VVS Radial pressure gauge

VEB Electrical vacuum indicator

VLB Electrical / visual vacuum indicator

MPS200 - MPS250

Filter size	H [mm]
200	213
250	262

Connections	T	R
G1	G 1/8"	M10
G2-G3	1/8" NPT	7/16" UNC

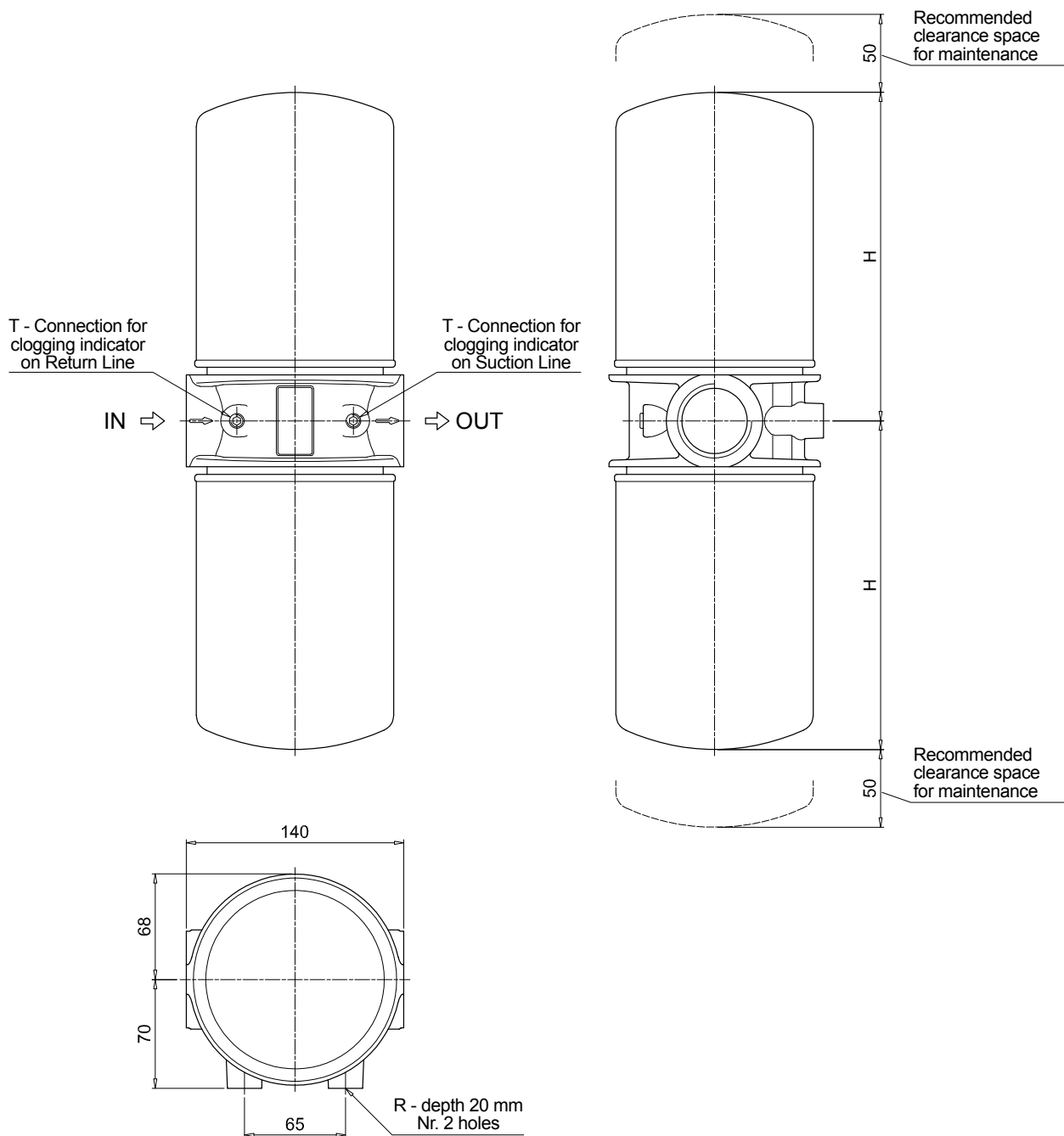

MPS MPS300 - MPS350 MPS301 - MPS351

Designation & Ordering code

COMPLETE FILTER

Series and size		Configuration example: MPS300 R F1 A10 A P01				
MPS300 MPS350	With connections for clogging indicators					
MPS301 MPS351	With connections for differential pressure indicators					
Bypass valve		MPS 300 - 350	MPS 301 - 351			
R	Inline / Return: with bypass 1.75 bar	•	•			
S	Inline / Suction: with bypass 0.3 bar	•	-			
U	Without bypass	•	-			
P	Without bypass	-	•			
Connections						
G1	G 1 1/2"					
G2	1 1/2" NPT					
G3	SAE 24 - 1 7/8" - 12 UN					
F1	1 1/2" SAE 3000 psi/M					
F2	1 1/2" SAE 3000 psi/UNC					
Filtration rating (filter media)						
A03	Inorganic microfiber 3 µm	M25	Wire mesh 25 µm			
A06	Inorganic microfiber 6 µm	M60	Wire mesh 60 µm			
A10	Inorganic microfiber 10 µm	M90	Wire mesh 90 µm			
A25	Inorganic microfiber 25 µm	P10	Resin impregnated paper 10 µm			
		P25	Resin impregnated paper 25 µm			
		Seal		Execution		
		A NBR		P01 MP Filtri standard		

CARTRIDGE

Cartridge series and size		Configuration example: CS100 A10 A P01			
CS100 CS150					
Filtration rating (filter media)					
A03	Inorganic microfiber 3 µm	M25	Wire mesh 25 µm		
A06	Inorganic microfiber 6 µm	M60	Wire mesh 60 µm		
A10	Inorganic microfiber 10 µm	M90	Wire mesh 90 µm		
A25	Inorganic microfiber 25 µm	P10	Resin impregnated paper 10 µm		
		P25	Resin impregnated paper 25 µm		
		Seals		Execution	
		A NBR		P01 MP Filtri standard	
				Pxx Customized	

CLOGGING INDICATORS

See page 714-715

Clogging indicators on RETURN line		
BVA	Axial pressure gauge	BEA Electrical pressure indicator
BVR	Radial pressure gauge	BEM Electrical pressure indicator
BVP	Visual pressure indicator with automatic reset	BLA Electrical / visual pressure indicator
BVQ	Visual pressure indicator with manual reset	
Clogging indicators on SUCTION line		
VVB	Axial pressure gauge	VEB Electrical vacuum indicator
VVS	Radial pressure gauge	VLB Electrical / visual vacuum indicator
Differential indicators		
DEA	Electrical differential pressure indicator	DLE Electrical / visual differential pressure indicator
DEM	Electrical differential pressure indicator	DTA Electronic differential pressure indicator
DEU	Electrical differential pressure indicator	DVA Visual differential pressure indicator
DLA	Electrical / visual differential pressure indicator	DVM Visual differential pressure indicator

PLUGS

See page 737

T2	Plug (not included)
-----------	---------------------

MPS300 - MPS350

Filter size	H [mm]
300	266
350	315

Connections	T	R
G1	G 1/8"	M10
G2-G3	1/8" NPT	7/16" UNC
F1	G 1/8"	M10
F2	1/8" NPT	7/16" UNC

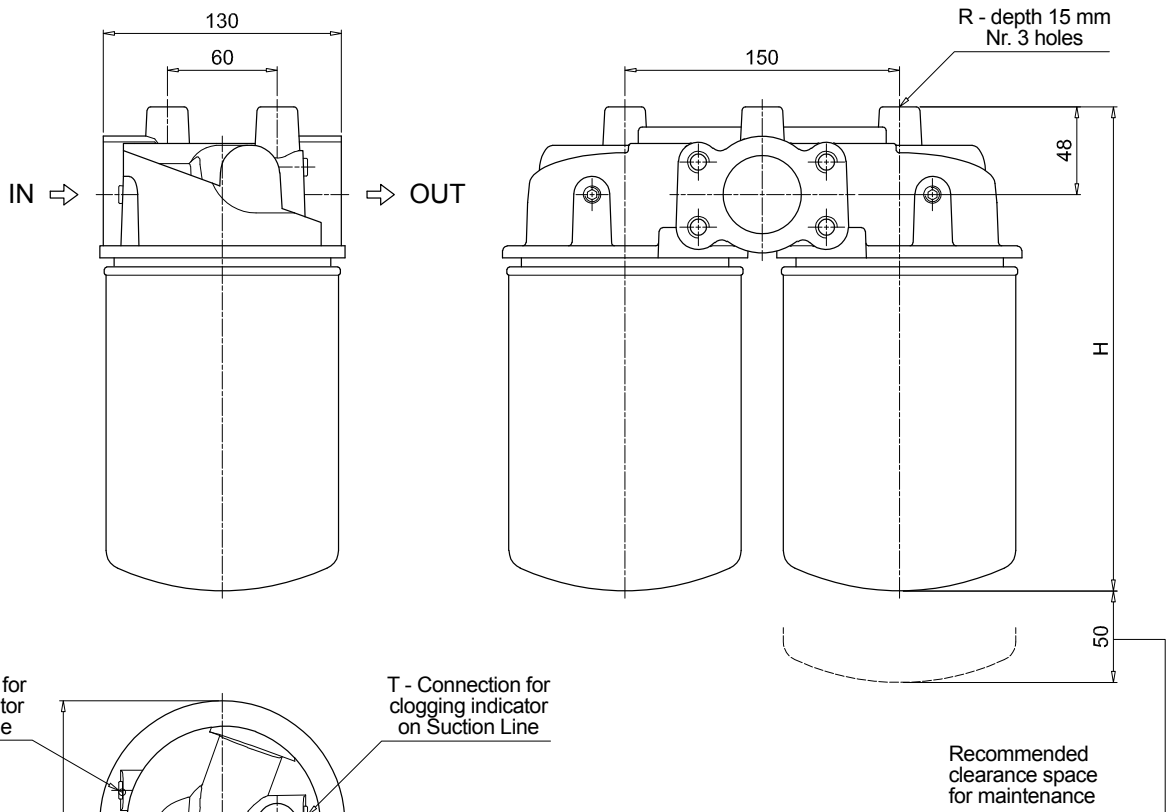

MPS MPS300 - MPS350 MPS301 - MPS351

Dimensions

MPS301 - MPS351

Filter size	H [mm]
301	266
351	315

Connections	R
G1	M10
G2-G3	7/16" UNC
F1	M10
F2	7/16" UNC

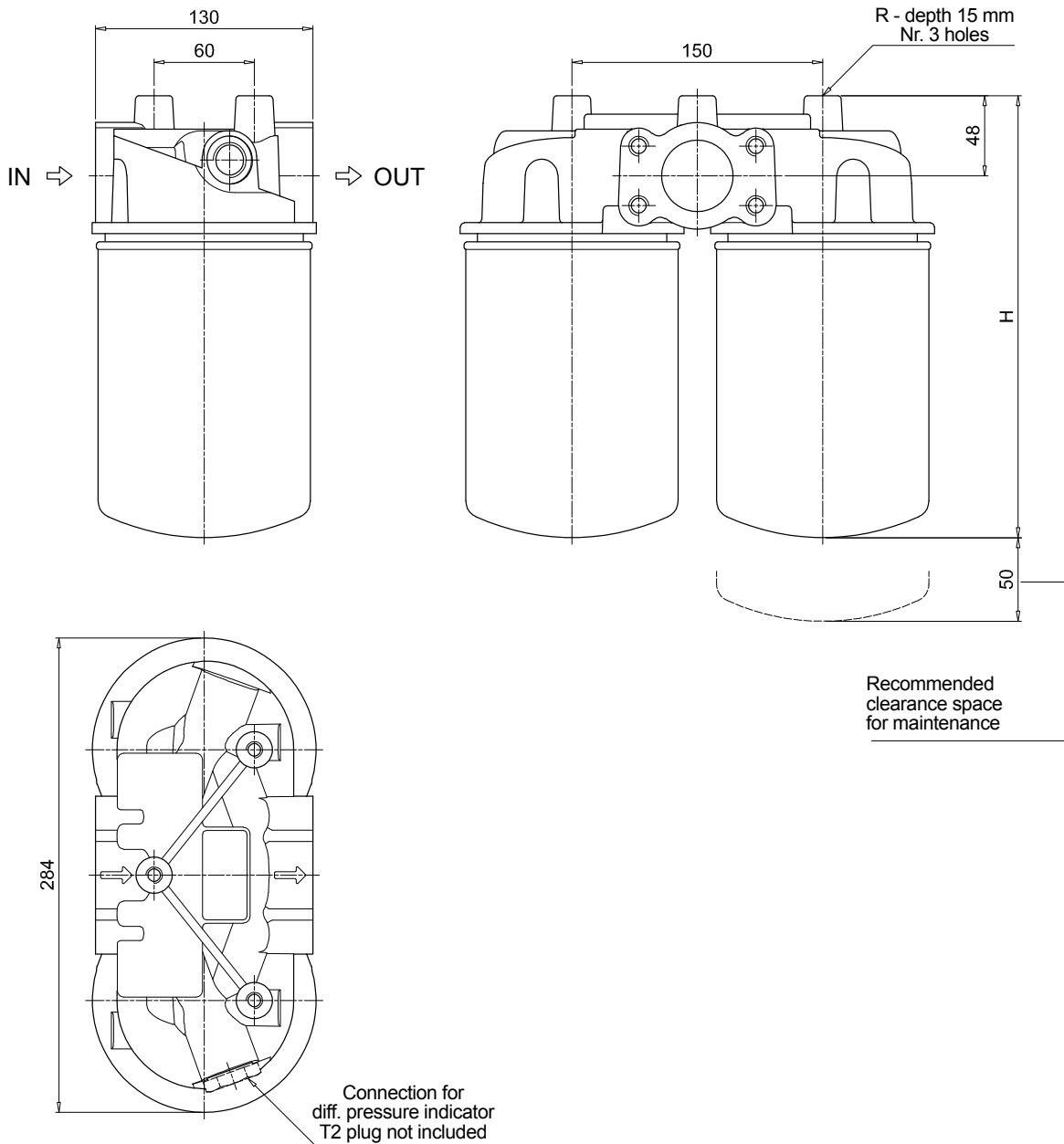

MSH series

Maximum working pressure up to 3.5 MPa (35 bar) - Flow rate up to 195 l/min



Description

Technical data

Spin-on filters

Maximum working pressure up to 3.5 MPa (35 bar)
Flow rate up to 195 l/min

MSH is a range of spin-on filters suitable to be used in low pressure lines. They offer a good balance between performances, dimensions and prices. They are directly connected to the lines of the system through the hydraulic fittings.

Available features:

- Female threaded connections up to 1 1/4", for a maximum flow rate of 195 l/min
- Fine filtration rating, to get a good cleanliness level into the reservoir
- Strong sealing between the housing and cans, to be used in heavy applications
- Bypass valve, to relieve excessive pressure drop across the filter media
- Visual, electrical and electronic differential clogging indicators for low pressure applications

Common applications:

- Delivery lines, in economic industrial equipment or mobile machines

Filter housing materials

- Head: Anodized Aluminium
- Bypass valve: Nylon - Steel
- Element: Aluminium - Painted Steel

Bypass valve

Opening pressure: 250 kPa (2.5 bar) ±10%

Δp element type

- Δp: 5 bar
- Oil flow from OUT to IN

Seals

- Standard NBR - series A
- Optional FPM - series V

Temperature

From -20 °C to +110 °C

Note

MSH filters are provided for vertical mounting



Weights [kg] and volumes [dm³]

Filter series	Weights [kg]	Volumes [dm ³]
MSH 050	1.50	0.65
MSH 070	1.90	0.95
MSH 100	3.30	1.80
MSH 150	3.80	2.20

Cartridge

Thread connections	
Type	Connection
CH 050 - 070	M32 x 2
CH 100 - 150	M45 x 2

CH

Filter series	Style S	Style B
MSH 050	•	•
MSH 070	•	•
MSH 100	•	•
MSH 150	•	•

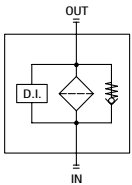
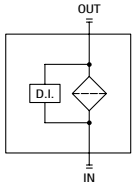

Pressure drop

Bypass valve pressure drop

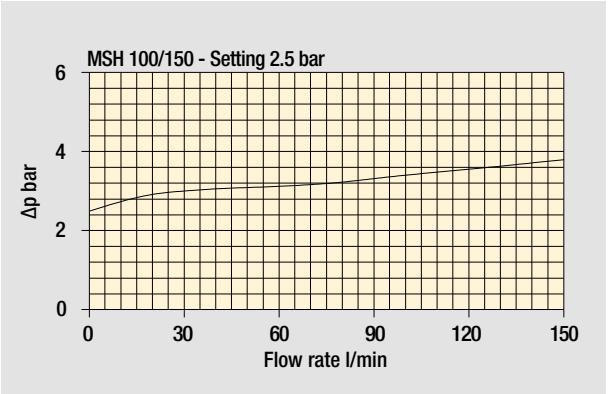
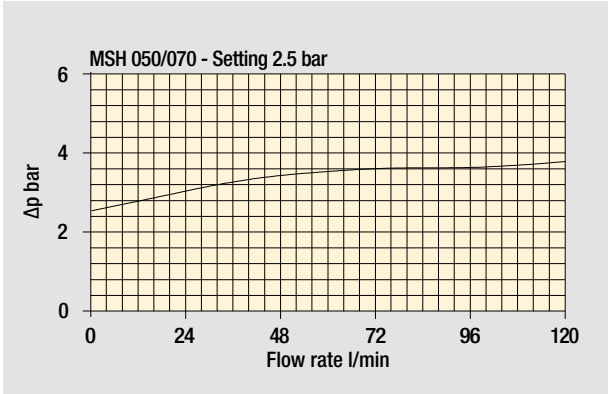

The curves are plotted using mineral oil with density of 0.86 kg/dm³ in compliance with ISO 3968. Δp varies proportionally with density.

MSH MSH050 - MSH070 MSH100 - MSH150

Designation & Ordering code

COMPLETE FILTER

Series and size **MSH050** | **MSH070** | **MSH100** | **MSH150** Configuration example: **MSH050** **B** **A** **G1** **A10** **P01**

Bypass valve
S Without bypass
B 2.5 bar

Seal
A NBR

Connections	MSH 050 - 070	MSH 100 - 150
G1	G 1"	G 1 1/2"
G2	G 3/4"	G 1 1/4"
G3	1" NPT	1 1/2" NPT
G4	3/4" NPT	1 1/4" NPT
G5	SAE 16 - 1 5/16" - 12 UN	SAE 24 - 1 7/8" - 12 UN
G6	SAE 12 - 1 1/16" - 12 UN	SAE 20 - 1 5/8" - 12 UN

Filtration rating (filter media)

A03 Inorganic microfiber 3 µm	M25 Wire mesh 25 µm
A06 Inorganic microfiber 6 µm	M60 Wire mesh 60 µm
A10 Inorganic microfiber 10 µm	M90 Wire mesh 90 µm
A25 Inorganic microfiber 25 µm	P10 Resin impregnated paper 10 µm
	P25 Resin impregnated paper 25 µm

Execution
P01 MP Filtri standard

CARTRIDGE

Cartridge series and size **CH050** | **CH070** | **CH100** | **CH150** Configuration example: **CH050** **A10** **A** **P01**

Filtration rating (filter media)

A03 Inorganic microfiber 3 µm	M25 Wire mesh 25 µm
A06 Inorganic microfiber 6 µm	M60 Wire mesh 60 µm
A10 Inorganic microfiber 10 µm	M90 Wire mesh 90 µm
A25 Inorganic microfiber 25 µm	P10 Resin impregnated paper 10 µm
	P25 Resin impregnated paper 25 µm

Seal
A NBR

Execution
P01 MP Filtri standard
Pxx Customized

CLOGGING INDICATORS

See page 714-715

Differential pressure indicators

DEA Electrical differential pressure indicator
DEM Electrical differential pressure indicator
DLA Electrical / visual differential pressure indicator
DLE Electrical / visual differential pressure indicator

DTA Electronic differential pressure indicator
DVA Visual differential pressure indicator
DVM Visual differential pressure indicator

PLUGS

See page 737

T2 Plug (not included)

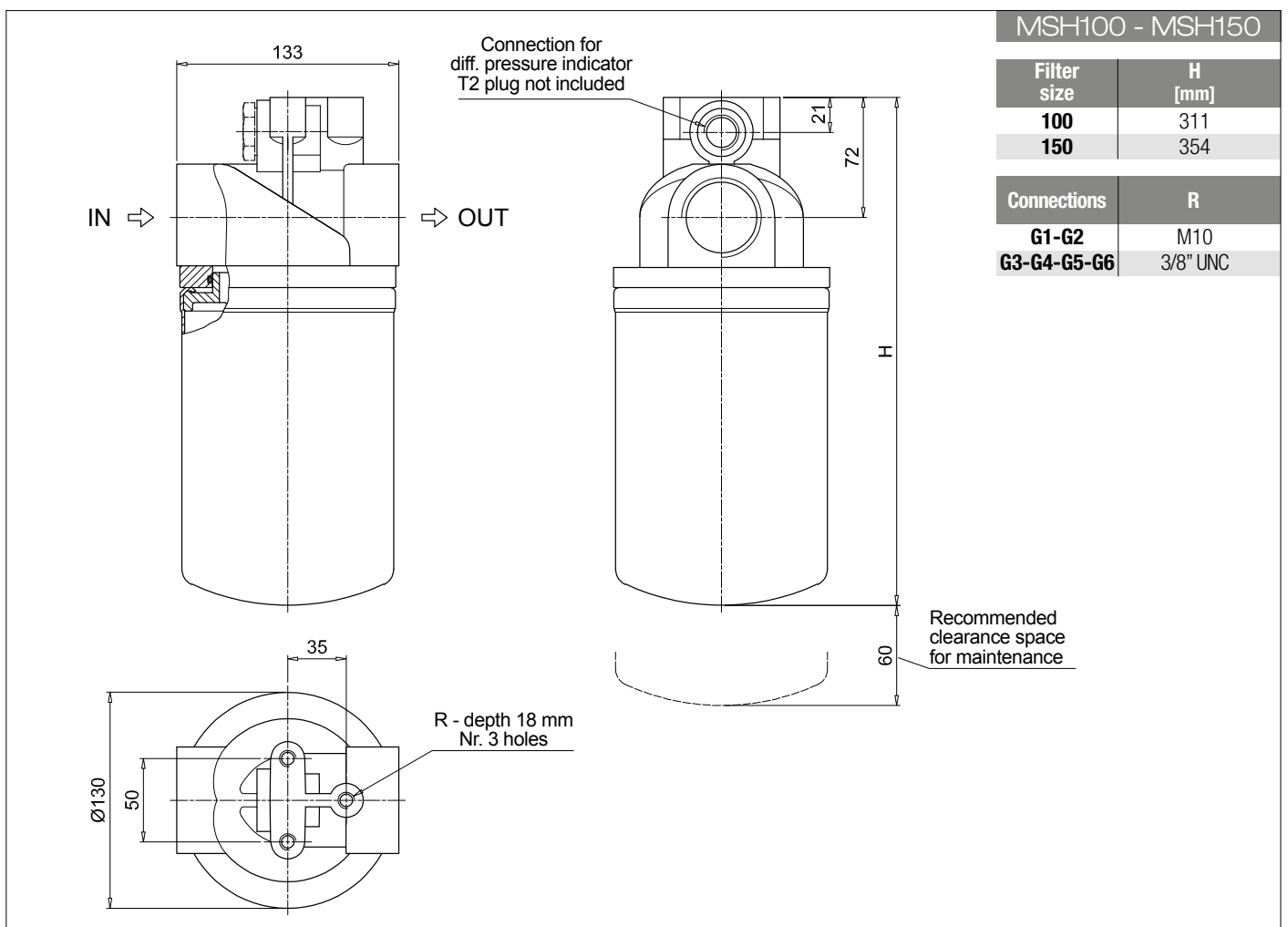
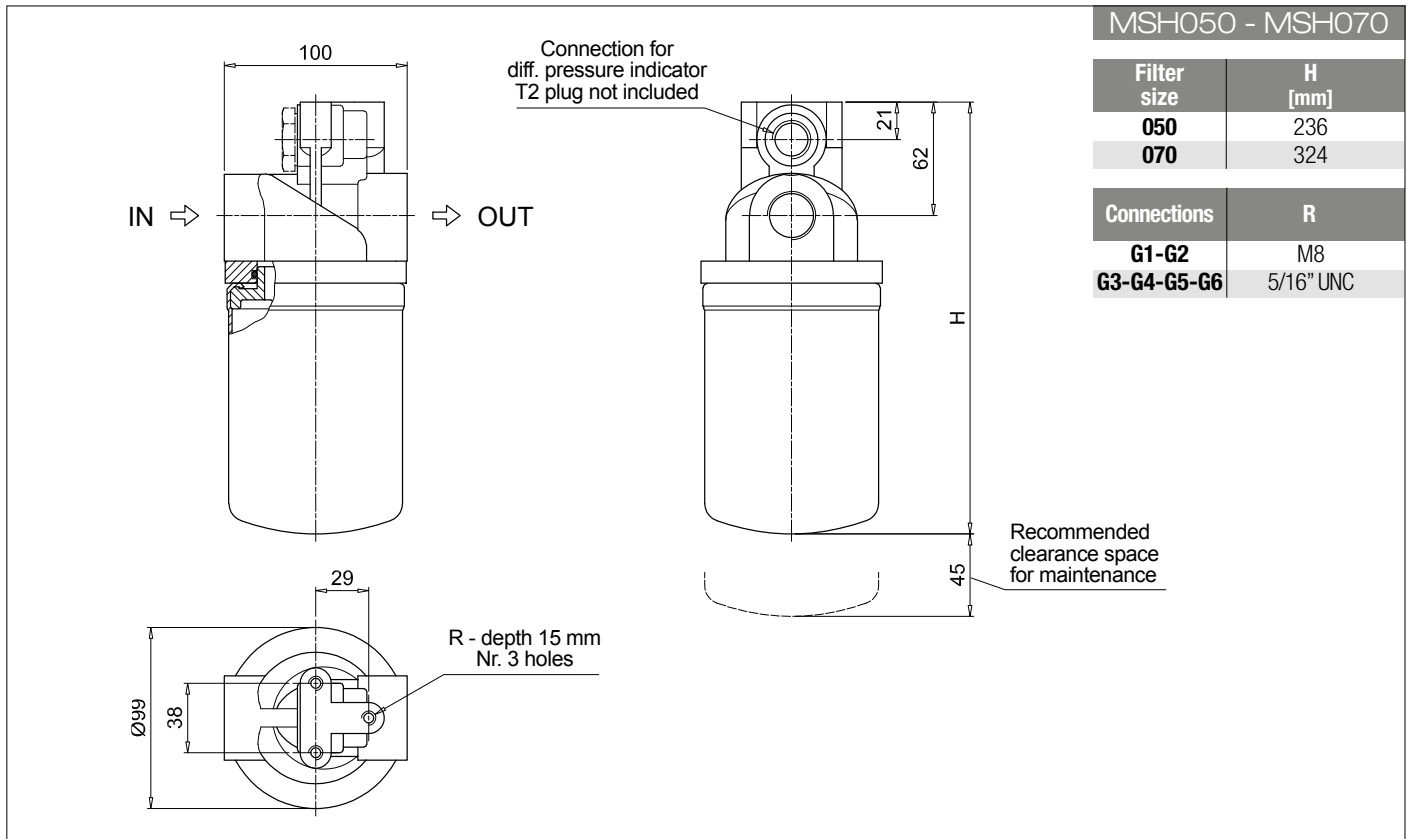

MSH SPARE PARTS

Order number for spare parts

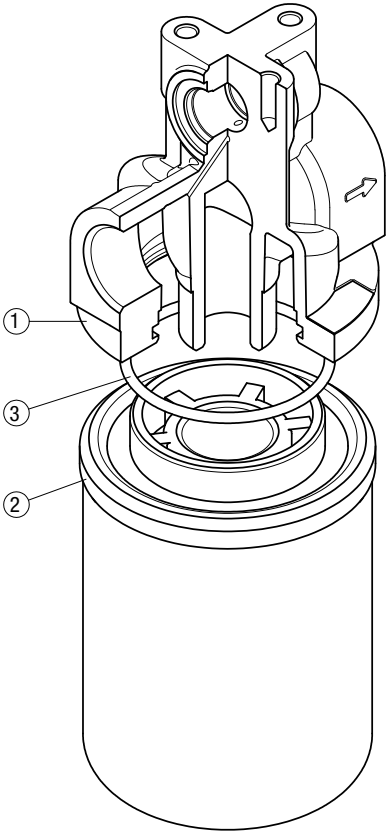

Item:	Q.ty: 1 pc. 1	Q.ty: 1 pc. 2	Q.ty: 1 pc. 3
Filter series	Filter assembly	Cartridge	Seal code number
MSH 050-070	See order table	See order table	0-R 167 (ø 63.50 x 3.53)
MSH 100-150	See order table	See order table	0-R 4362 (ø 91.67 x 3.53)

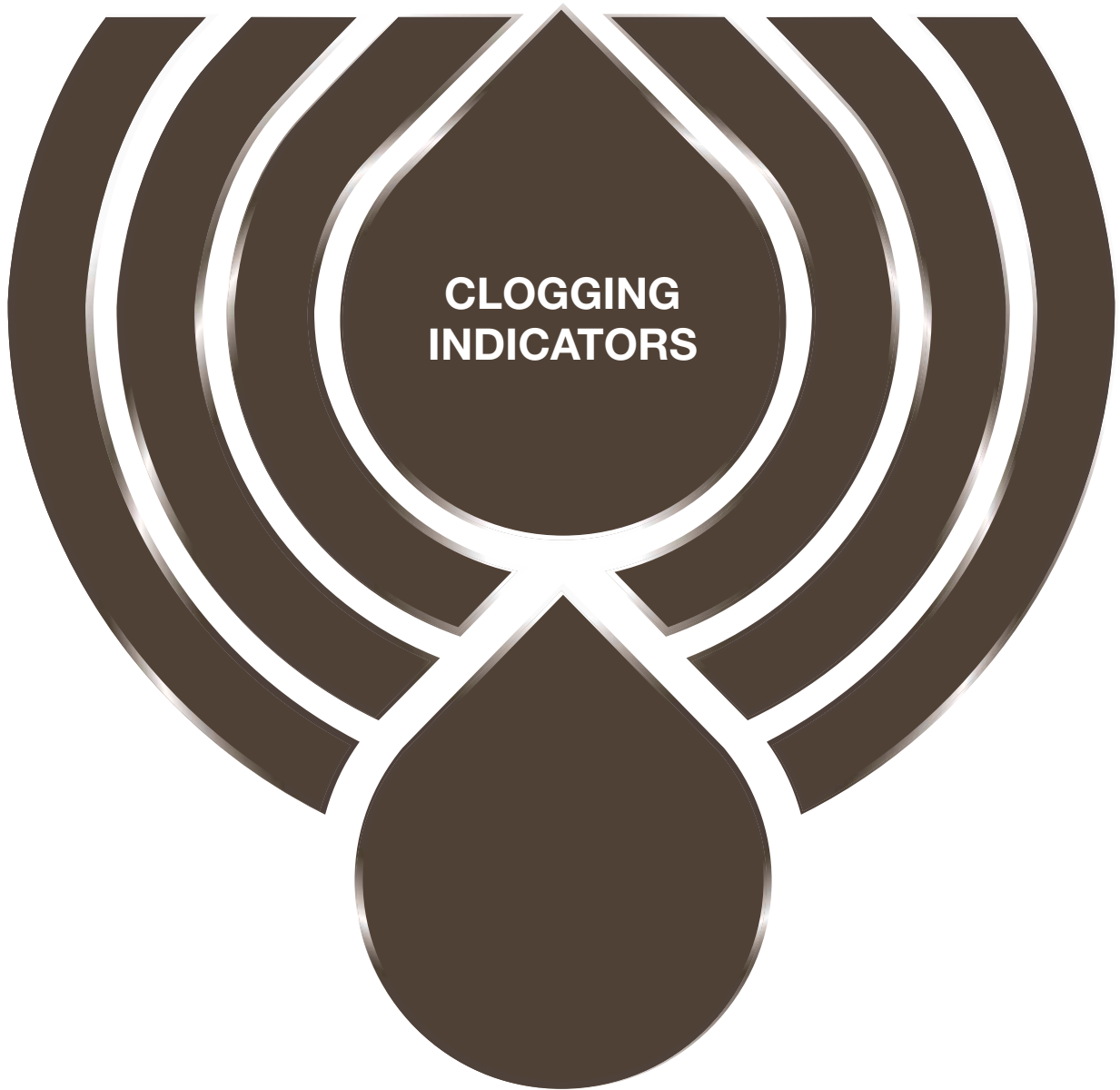

**CLOGGING
INDICATORS**

Clogging indicators are devices that check the life time of the filter elements. They measure the pressure drop through the filter element directly connected to the filter housing.

These devices trip when the clogging of the filter element causes a pressure drop increasing across the filter element.

Filter elements are efficient only if their Dirt Holding Capacity is fully exploited. This is achieved by using filter housings equipped with clogging indicators.

The indicator is set to alarm before the element becomes fully clogged.

MP Filtri can supply indicators of the following designs:

- Vacuum switches and gauges
- Pressure switches and gauges
- Differential pressure indicators

These type of devices can be provided with a visual, electrical or both signals. The electronic differential pressure clogging indicator is also available. It provides both analogical 4-20 mA output and digital warning (75% of clogging) and alarm (clogging) outputs.

In the following pages you can find a reference guide about the types of clogging indicators available in the different families of MP Filtri's Hydraulic Filtration range of products.

Clogging Indicators



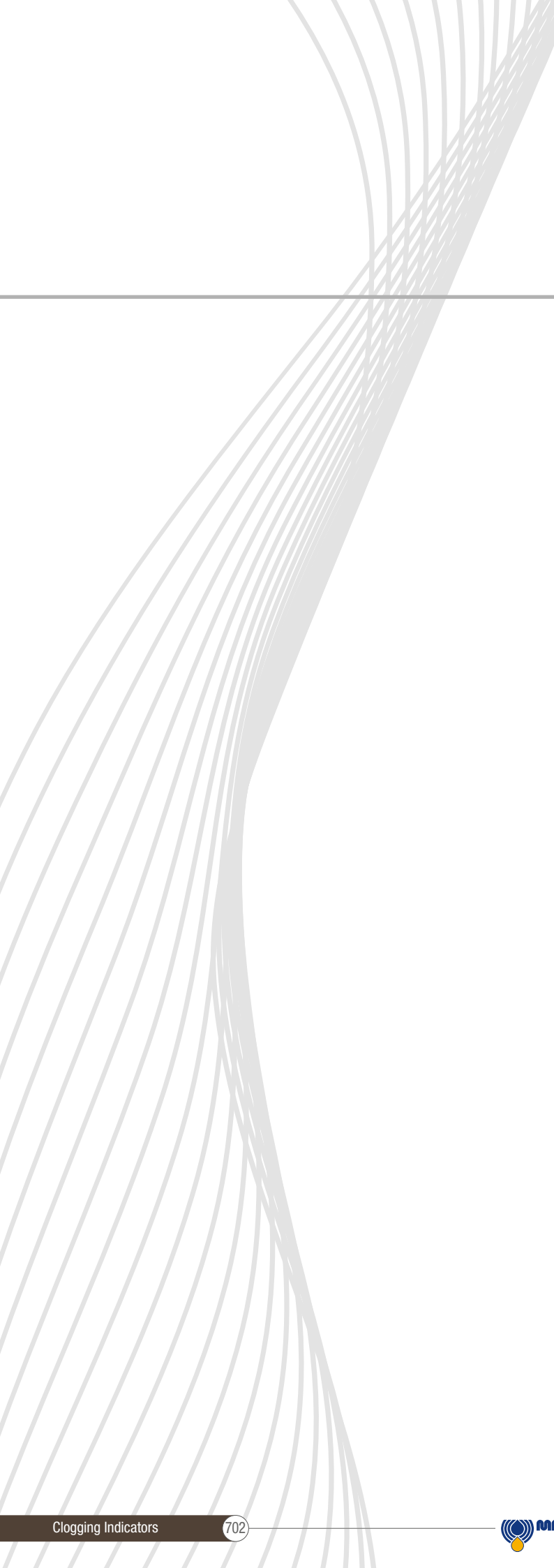

DESIGNATION, ORDERING CODES & TECHNICAL DATA

INDEX

	Page
QUICK REFERENCE GUIDE	704
CLOGGING INDICATORS ORDERING CODES	
SUCTION FILTERS INDICATORS	709
RETURN FILTERS INDICATORS	710
RETURN / SUCTION FILTERS INDICATORS	712
SPIN-ON FILTERS INDICATORS	714
LOW & MEDIUM PRESSURE FILTERS INDICATORS	716
HIGH PRESSURE FILTERS INDICATORS	717
STAINLESS STEEL HIGH PRESSURE FILTERS INDICATORS	718
FILTERS FOR POTENTIALLY EXPLOSIVE ATMOSPHERE INDICATORS	719
TECHNICAL DATA	
VACUUM INDICATORS	720
BAROMETRIC (PRESSURE) INDICATORS	722
DIFFERENTIAL PRESSURE INDICATORS	726
PLUGS	737

QUICK REFERENCE GUIDE

Ordering codes

Filter family	Filter series	Visual indicators	Electrical indicators	Electronic / Electrical-Visual indicators	
SUCTION FILTERS	ELIXIR® SFEX060-080-110-160	VVB20P01 VVS20P01	VEB21AA50P01	VLB21AA51P01 VLB21AA52P01 VLB21AA53P01 VLB21AA71P01	
	With bypass valve 0.3 bar	SF2 250 - 350 SF2 500 - 501 - 503 - 504 - 505 SF2 510 - 535 - 540	WA20P01 WR20P01	VEA21xA50P01 VEA21xA50P01UL	VLA21xA51P01 VLA21xA52P01 VLA21xA53P01 VLA21xA71P01
RETURN FILTERS	ELIXIR® RFEX060-080-110-160	BVA14P01 BVR14P01 BVP15HP01 BVQ15HP01	BEA15HA50P01 BEA15HA50P01UL BEM15HA41P01	BLA15HA51P01 BLA15HA52P01 BLA15HA53P01 BLA15HA71P01	
	With bypass 1.75 bar				
	ELIXIR® RFEX060-080-110-160	BVA25P01 BVR25P01 BVP20HP01 BVQ20HP01	BEA20HA50P01 BEA20HA50P01UL BEM20HA41P01	BLA20HA51P01 BLA20HA52P01 BLA20HA53P01 BLA20HA71P01	
	Without bypass				
	MDH 250	BVA14P01 BVR14P01 BVP15HP01 BVQ15HP01 DVS12HP01	BEA15HA50P01 BEA15HA50P01UL BEM15HA41P01 DES12HA10P01 DES12HA30P01 DES12HA80P01	BLA15HA51P01 BLA15HA52P01 BLA15HA53P01 BLA15HA71P01	
	With bypass 1.75 bar				
	MDH 250	BVA25P01 BVR25P01 BVP20HP01 BVQ20HP01 DVS25HP01	BEA20HA50P01 BEA20HA50P01UL BEM20HA41P01 DES25HA10P01 DES25HA30P01 DES25HA80P01	BLA20HA51P01 BLA20HA52P01 BLA20HA53P01 BLA20HA71P01	
	With bypass 3 bar				
	With bypass 1.75 bar	MPFX MPTX MPF MPT MPH	BVA14P01 BVR14P01 BVP15HP01 BVQ15HP01	BEA15HA50P01 BEA15HA50P01UL BEM15HA41P01	BLA15HA51P01 BLA15HA52P01 BLA15HA53P01 BLA15HA71P01
	With bypass 3 bar				
With bypass 3 bar	MPFX MPTX MPF MPT	BVA25P01 BVR25P01 BVP20HP01 BVQ20HP01	BEA20HA50P01 BEA20HA50P01UL BEM20HA41P01	BLA20HA51P01 BLA20HA52P01 BLA20HA53P01 BLA20HA71P01	
With bypass 2.5 bar					
With bypass 2.5 bar	MPH				
With bypass 4.5 bar	MPLX	DVA20xP01	DEA20xA50P01 DEA20xA50P01UL	DLA20xA51P01 DLA20xA52P01 DLA20xA71P01	
With bypass 2.4 bar	FRI	DVM20xP01	DEM20xx10P01 DEM20xx20P01 DEM20xx30P01 DEM20xx35P01 DEU20xA50P01UL	DLE20xA50P01 DLE20xF50P01 DTA20xF70P01	

QUICK REFERENCE GUIDE

Ordering codes

Filter family	Filter series	Visual indicators	Electrical indicators	Electronic / Electrical-Visual indicators	
RETURN / SUCTION FILTERS	MRSX 116 - 165 - 166 Suction line	VVB20P01	VEB21AA50P01	VLB21AA51P01 VLB21AA52P01 VLB21AA53P01 VLB21AA71P01	
		VVS20P01			
	With bypass valve 2.5 bar	MRSX 116 - 165 - 166 Return line	BVA25P01	BEA20HA50P01 BEA20HA50P01UL	BLA20HA51P01 BLA20HA52P01 BLA20HA53P01 BLA20HA71P01
			BVR25P01 BVP20HP01 BVQ20HP01	BEM20HA41P01 BET25HF10P01 BET25HF30P01 BET25HF50P01	
	With bypass valve 2.5 bar	LMP 124 MULTIPORT	BVA25P01	BEA20HA50P01 BEA20HA50P01UL	BLA20HA51P01 BLA20HA52P01 BLA20HA53P01 BLA20HA71P01
			BVR25P01	BEM20HA41P01	
			BVP20HP01	BET25HF10P01 BET25HF30P01 BET25HF50P01	DLA20xA51P01 DLA20xA52P01 DLA20xA71P01 DLE20xA50P01 DLE20xF50P01
			BVQ20HP01	DEA20xA50P01	
			DVA20xP01	DEM20xx10P01 DEM20xx20P01 DEM20xx30P01 DEM20xx35P01	
			DVM20xP01	DEU20xA50P01UL	
Suction line	MPS 050 - 070 - 100 - 150 MPS 200 - 250 - 300 - 350	WB20P01	VEB21AA50P01	VLB21AA51P01 VLB21AA52P01 VLB21AA53P01 VLB21AA71P01	
		VVS20P01			
SPIN-ON FILTERS	Return line	MPS 050 - 070 - 100 - 150	BVA14P01	BEA15HA50P01	BLA15HA51P01 BLA15HA52P01 BLA15HA53P01 BLA15HA71P01
		MPS 200 - 250 - 300 - 350	BVR14P01	BEA15HA50P01UL	
		MST 050 - 070 - 100 - 150	BVP15HP01 BVQ15HP01	BEM15HA41P01	
In-line	MPS 051 - 071 - 101 - 151 MPS 301 - 351 MSH 050 - 070 - 100 - 150	DVA12xP01	DEA12xA50P01	DLA12xA51P01 DLA12xA52P01 DLA12xA71P01 DLE12xA50P01 DLE12xF50P01 DLE20xF50P01 DLE20xF50P01	
		DVM12xP01	DEM12xAxxP01 DEU20xA50P01UL		DTA12xF70P01 DTA20xF70P01

QUICK REFERENCE GUIDE

Ordering codes

Filter family	Filter series	Visual indicators	Electrical indicators	Electronic / Electrical-Visual indicators		
LOW & MEDIUM PRESSURE FILTERS	ELIXIR® LFEX060-080-110-160	DVS25HP01	DES25HA10P01 DES25HA30P01 DES25HA80P01			
	With bypass valve 3.5 bar	LMP 110 LMP 112 - 116 - 118 - 119 MULTIPORT LMP 120 - 122 - 123 MULTIPORT LMP 210 - 211 - LDP LMP 400 - 401 & 430 - 431 LMP 900 - 901 LMP 902 - 903	DVA20XP01 DVM20XP01	DEA20xA50P01 DEM20xx10P01 DEM20xx20P01 DEM20xx30P01 DEM20xx35P01 DEU20xA50P01UL	DLA20xA51P01 DLA20xA52P01 DLA20xA71P01 DLE20xA50P01 DLE20xF50P01 DTA20xF70P01	
	With bypass valve 2.5 bar	LPH 630	DVA20XP01 DVM20XP01	DEA20xA50P01 DEM20xx10P01 DEM20xx20P01 DEM20xx30P01 DEM20xx35P01 DEU20xA50P01UL	DLA20xA51P01 DLA20xA52P01 DLA20xA71P01 DLE20xA50P01 DLE20xF50P01 DTA20xF70P01	
	With bypass valve 1.75 bar	LPH 630	DVA12XP01 DVM12XP01 DVS12HP01	DEA12xA50P01 DEM12xx10P01 DEM12xx20P01 DEM12xx30P01 DEM12xx35P01	DLA12xA51P01 DLA12xA52P01 DLA12xA71P01 DLE12xA50P01 DLE12xF50P01 DTA12xF70P01	
	HIGH PRESSURE FILTERS	ELIXIR® LFEX060-080-110-160	DVS40HP01	DES40HA10P01 DES40HA30P01 DES40HA80P01		
		Without bypass valve	LMP 110 LMP 112 - 116 - 118 - 119 MULTIPORT LMP 120 - 122 - 123 MULTIPORT LMP 210 - 211 - LDP LMP 400 - 401 & 430 - 431 LMP 900 - 901 LMP 902 - 903 LMP 950 - 951 LMP 952 - 953 - 954 LMD 211 - 400 - 401 - 431 - 951 - LDD LPH 630	DVA50XP01 DVM50XP01	DEA50xA50P01 DEM50xx10P01 DEM50xx20P01 DEM50xx30P01 DEM50xx35P01 DEU50xA50P01UL	DLA50xA51P01 DLA50xA52P01 DLA50xA71P01 DLE50xA50P01 DLE50xF50P01 DTA50xF70P01
		With bypass valve 6 bar	FMP 039 - 065 - 135 - 320 FHP 010 - 011 - 065 - 135 - 350 - 351 - 500 FMMX 050 FMM 050 - 150 FHA 051 FHM 006 - 007 - 010 - 050 - 065 - 135 - 320 - 500 FHB 050 - 135 - 320 FHF 325 FHD 021 - 051 - 326 - 333	DVA50XP01 DVM50XP01	DEA50xA50P01 DEM50xx10P01 DEM50xx20P01 DEM50xx30P01 DEM50xx35P01 DEU50xA50P01UL	DLA50xA51P01 DLA50xA52P01 DLA50xA71P01 DLE50xA50P01 DLE50xF50P01
		Without bypass valve	FMP 039 - 065 - 135 - 320 FHP 010 - 011 - 065 - 135 - 350 - 351 - 500 FMMX 050 FMM 050 - 150 FHA 051 FHM 006 - 007 - 010 - 050 - 065 - 135 - 320 - 500 FHB 050 - 135 - 320 FHF 325 FHD 021 - 051 - 326 - 333	DVA70XP01 DVA95XP01 DVM70XP01 DVM95XP01	DEA70xA50P01 DEA95xA50P01 DEM70xx10P01 DEM70xx20P01 DEM70xx30P01 DEM70xx35P01 DEU70xA50P01UL DEM95xx10P01 DEM95xx20P01 DEM95xx30P01 DEM95xx35P01	DLA70xA51P01 DLA70xA52P01 DLA70xA71P01 DLA95xA51P01 DLA95xA52P01 DLA95xA71P01 DLE70xA50P01 DLE70xF50P01 DLE95xA50P01 DLE95xF50P01 DTA70xF70P01 DTA95xF70P01

Filter family	Filter series	Visual indicators	Electrical indicators	Electronic / Electrical-Visual indicators
STAINLESS STEEL HIGH PRESSURE FILTERS	With bypass valve 6 bar	FZH 012 - 040	DVZ50xP01	DEZ50xA50P01 DLZ50xA51P01 DLZ50xA52P01
	Without bypass valve	FZH 012 - 040	DVZ70xP01 DVZ95xP01	DEZ70xA50P01 DEZ95xA50P01 DLZ70xA51P01 DLZ70xA52P01 DLZ95xA51P01 DLZ95xA52P01
	With bypass valve 6 bar	FZP 039 - 136 FZB 039 FZM 039 FZD 051	DVX50xP01 DYY50xP01	DEX50xA50P01 DLX50xA51P01 DLX50xA52P01
	Without bypass valve	FZP 039 - 136 FZB 039 FZM 039 FZD 010 - 021 - 051	DVX70xP01 DVX95xP01 DYY70xP01 DYY95xP01	DEX70xA50P01 DEX95xA50P01 DLX70xA51P01 DLX70xA52P01 DLX95xA51P01 DLX95xA52P01
	With bypass valve 6 bar	FMMX 050	DVA50xP01 DVM50xP01	DEH50xA48P01 DEH50xA49P01 DEH50xA70P01
	Without bypass valve	FMMX 050	DVA70xP01 DVA95xP01 DVM70xP01 DVM95xP01	DEH70xA48P01 DEH70xA49P01 DEH70xA70P01 DEH95xA48P01 DEH95xA49P01 DEH95xA70P01
	With bypass valve 6 bar	FZP 039 - 136	DVX50xP01 DYY50xP01	DEH50xA48P01 DEH50xA49P01 DEH50xA70P01
	Without bypass valve	FZP 039 - 136	DVX70xP01 DVX95xP01 DYY70xP01 DYY95xP01	DEH70xA48P01 DEH70xA49P01 DEH70xA70P01 DEH95xA48P01 DEH95xA49P01 DEH95xA70P01
FILTERS FOR POTENTIALLY EXPLOSIVE ATMOSPHERE	With bypass valve 6 bar	FZH 012 - 040	DVZ50xP01	
	Without bypass valve	FZH 012 - 040	DVZ70xP01 DVZ95xP01	

Suitable indicator types

V ACUUM INDICATORS

Vacuum indicators are used on the Suction line to check the efficiency of the filter element.

They measure the pressure downstream of the filter element.

Standard items are produced with R 1/4" EN 10226 connection.

Available products with R 1/8" EN 10226 to be fitted on MPS series.

Vacuum indicators are identified in the Hydraulic Filtration catalogue and in the Quick Reference Guide table by the letter "V".

Example:

V VVB20P01

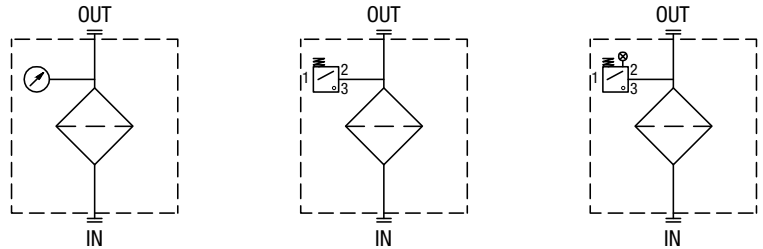

B BAROMETRIC (PRESSURE) INDICATORS

Pressure indicators are used on the Return line to check the efficiency of the filter element.

They measure the pressure upstream of the filter element.

Standard items are produced with R 1/8" EN 10226 connection.

Barometric (pressure) indicators are identified in the Hydraulic Filtration catalogue and in the Quick Reference Guide table by the letter "B".

Example:

B BVA14P01

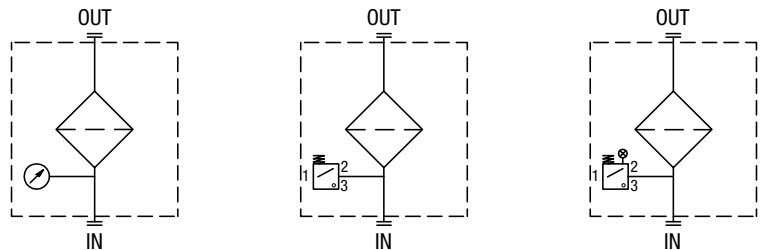

D DIFFERENTIAL PRESSURE INDICATORS

Differential pressure indicators are used on the Pressure line to check the efficiency of the filter element.

They measure the pressure upstream and downstream of the filter element (differential pressure).

Standard items are produced with special connection G 1/2" size.

Also available in Stainless Steel models. Differential pressure indicators are identified in the Hydraulic Filtration catalogue and in the Quick Reference Guide table by the letter "D".

Example:

D DVA20xP01

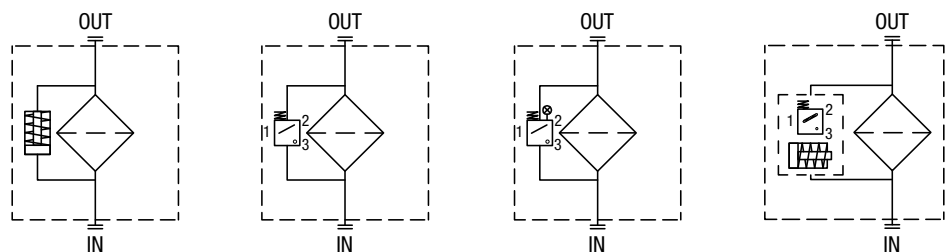

DIFFERENTIAL PRESSURE INDICATORS

Series		Configuration example 1:						
DE Electrical differential pressure indicator		DE	M	12	H	F	50	P01
DL Electrical/Visual differential pressure indicator		Configuration example 2:						
DT Electronic differential pressure indicator		DE	U	50	H	A	50	P01
DV Visual differential pressure indicator		Configuration example 3:						
		DL	E	20	V	A	71	P01
		Configuration example 4:						
		DT	A	50	H	F	70	P01
		Configuration example 5:						
		DV	M	70	V			P01

Type	DE	DL	DT	DV
A Standard type	•	•	•	A With automatic reset
M With wired electrical connection	•	-	-	M With manual reset
U Standard type 210 bar, UL certified	•	-	-	
E For high power supply	-	•	-	

Pressure setting	
12	1.2 bar
20	2.0 bar
50	5.0 bar
70	7.0 bar
95	9.5 bar

Seals	
H	HNBR
V	FPM

Thermostat	DEA	DEM	DLA	DLE	DT
A Without thermostat	•	•	•	•	-
F With thermostat	-	•	-	•	•

Electrical connections	DEA	DEM	DLA	DLE	DT
10 Connection AMP Superseal series 1.5	-	•	-	-	-
20 Connection AMP Timer Junior	-	•	-	-	-
30 Connection Deutsch DT-04-2-P	-	•	-	-	-
35 Connection Deutsch DT-04-3-P	-	•	-	-	-
50 Connection EN 175301-803	•	-	-	•	-
51 Connection EN 175301-803, transparent base with lamps 24 Vdc	-	-	•	-	-
52 Connection EN 175301-803, transparent base with lamps 110 Vdc	-	-	•	-	-
70 Connection IEC 61076-2-101 D (M12)	-	-	-	-	•
71 Connection IEC 61076-2-101 D (M12), black base with lamps 24 Vdc	-	-	•	-	-

Option	
P01	MP Filtri standard
Pxx	Customized

Certifications	DEU	OTHERS
Without	-	•
UL UL certification	•	-

PLUGS

Series	Configuration example
T2 Plug	T2 H

Seals	
H	HNBR
V	FPM

DIFFERENTIAL PRESSURE INDICATORS

Dimensions

DEA*50	
Electrical Differential Pressure Indicator Connection: EN 175301-803	
Settings	Ordering code
1.2 bar ±10%	DE A 12 x A 50 P01
2.0 bar ±10%	DE A 20 x A 50 P01
5.0 bar ±10%	DE A 50 x A 50 P01
7.0 bar ±10%	DE A 70 x A 50 P01
9.5 bar ±10%	DE A 95 x A 50 P01

A/F 30
Max tightening torque: **65 N·m**

Hydraulic symbol

Electrical symbol

Materials

- Body: Brass
- Base: Black polyamide
- Contacts: Silver
- Seal: HNBR - FPM

Technical data

- Max working pressure: 420 bar
- Proof pressure: 630 bar
- Burst pressure: 1260 bar
- Working temperature: From -25 °C to +110 °C
- Compatibility with fluids: Mineral oils, Synthetic fluids
HFB and HFC according to ISO 2943
- Degree protection: IP66 according to EN 60529
IP69K according to ISO 20653

Electrical data

- Electrical connection: EN 175301-803
- Resistive load: 0.2 A / 115 Vdc

DEH*48	
Hazardous Area Electrical Differential Pressure Indicator Connection via three-core cable - fitting M20x1.5	
Settings	Ordering code
2.0 bar ±10%	DE H 20 x A 48 P01
5.0 bar ±10%	DE H 50 x A 48 P01
7.0 bar ±10%	DE H 70 x A 48 P01

A/F 25
Max tightening torque: **100 N·m**

M20 x 1.5
flexible cable ≈ 5000 to A

min. 110
88

Hydraulic symbol

Electrical symbol

Materials

- Body: AISI 316L
- Contacts: Rhodium
- Seal: FPM - MFQ

Technical data

- Max working pressure: 420 bar
- Proof pressure: 630 bar
- Burst pressure: 1260 bar
- Working temperature: From -60 °C to +125 °C
- Compatibility with fluids: Mineral oils, Synthetic fluids
HFB and HFC according to ISO 2943
- Temperature class: T4 (135 °C) and T6 (85 °C)
- Degree of protection: IP 66/67/68 according to EN 60529
- Connection type: Three-core cable, fitting M20x1.5
- Contact type: SPCO/SPDT (Hermetically sealed - Volt-free contacts)

Electrical data

- Connection via three-core cable - fitting M20x1.5
- Resistive Load: 830 mA / 24 Vdc - 180 mA / 110 Vac
- Electrical Ratings: $U_i = 30 \text{ Vdc} / I_i = 250 \text{ mA} / P_i = 1.3 \text{ W}$
- Available ATEX product: II 1 GD Ex ia IIC T6 Ga -60°C ≤ Ta ≤ 80°C
Ex ia IIC T4 Ga -60°C ≤ Ta ≤ 125°C
II 2 GD Ex db IIC T6* Gb Ex tb IIIC T85°C* Db
(Tamb : = -60°C to +70°C)* IP66/67
* alternative T/Class and ambients T4, T135°C
(Tamb = -60°C to +120°C)

Certification / Approvals:
ATEX, IECEx, EAC TR CU, INMETRO
- Certification included as standard

DEH*49	
Hazardous Area Electrical Differential Pressure Indicator Connection via four-core cable - fitting 1/2" NPT	
Settings	Ordering code
2.0 bar ±10%	DE H 20 x A 49 P01
5.0 bar ±10%	DE H 50 x A 49 P01
7.0 bar ±10%	DE H 70 x A 49 P01

A/F 25
Max tightening torque: **100 N·m**

1/2" NPT
flexible cable ≈ 5000 to A

min. 110
88

Hydraulic symbol

Electrical symbol

Materials

- Body: AISI 316L
- Contacts: Rhodium
- Seal: FPM - MFQ

Technical data

- Max working pressure: 420 bar
- Proof pressure: 630 bar
- Burst pressure: 1260 bar
- Working temperature: From -60 °C to +120 °C : ATEX, IECEx, EAC TR CU, INMETRO
From -60 °C to +105 °C : UL/CSA
- Compatibility with fluids: Mineral oils, Synthetic fluids
HFB and HFC according to ISO 2943
- Temperature class: T4 (135 °C) and T6 (85 °C)
- Degree of protection: IP 66/67/68 according to EN 60529
- Connection type: Four-core cable, fitting 1/2" NPT
- Contact type: SPCO/SPDT (Hermetically sealed - Volt-free contacts)

Electrical data

- Connection via four-core cable - fitting 1/2" NPT
- Resistive Load: 830 mA / 24 Vdc - 180 mA / 110 Vac
- Max voltage: 150 Vac/dc
- Power: 20 W
- Available ATEX product: II 1 GD Ex ia IIC T6 Ga -60°C ≤ Ta ≤ 80°C
Ex ia IIC T4 Ga -60°C ≤ Ta ≤ 125°C
II 2 GD Ex db IIC T6* Gb Ex tb IIIC T85°C* Db
(Tamb : = -60°C to +70°C)* IP66/67
* alternative T/Class and ambients T4, T135°C
(Tamb = -60°C to +120°C)

Certification / Approvals:
ATEX, IECEx, EAC TR CU, INMETRO, UL/CSA Class I Division 1 Groups A-D, UL/CSA Class II Division 1 Groups E-G
- Certification included as standard

DEH*70		Hydraulic symbol	Materials
Hazardous Area Electrical Differential Pressure Indicator Connection IEC 61076-2-101 D (M12)			
Settings	Ordering code		
2.0 bar ±10%	DE H 20 x A 70 P01	Electrical symbol 	Technical data - Max working pressure: 420 bar - Proof pressure: 630 bar - Burst pressure: 1260 bar - Working temperature: From -60 °C to +80 °C - Compatibility with fluids: Mineral oils, Synthetic fluids HFB and HFC according to ISO 2943 - Temperature class: T6 (85 °C) - Degree of protection: IP 66/67 according to EN 60529 - Connection type: IEC 61076-2-101 D (M12) - Contact type: SPCO/SPDT (Hermetically sealed - Volt-free contacts)
5.0 bar ±10%	DE H 50 x A 70 P01		
7.0 bar ±10%	DE H 70 x A 70 P01		
		Electrical data - Connection IEC 61076-2-101 D (M12) - Resistive Load: 830 mA / 24 Vdc - 180 mA / 110 Vdc - Electrical Ratings: <i>U_i</i> = 30 Vdc <i>I_i</i> = 250 mA <i>P_i</i> = 1.3 W - Available ATEX product: II 1 GD Ex ia IIC T6 Ga -60°C ≤ Ta ≤ 80°C Ex ia IIC T4 Ga -60°C ≤ Ta ≤ 125°C II 2 GD Ex db IIC T6* Gb Ex tb IIIC T85°C* Db (Tamb = -60°C to +70°C)* IP66/67 * alternative T/Class and ambients T4, T135°C (Tamb = -60°C to +120°C)	

DEM*F10		Hydraulic symbol	Materials
Electrical Differential Pressure Indicator Connection: AMP Superseal series 1.5			
Settings	Ordering code		
1.2 bar ±10%	DE M 12 x F 10 P01	Electrical symbol 	Technical data - Max working pressure: 420 bar - Proof pressure: 630 bar - Burst pressure: 1260 bar - Working temperature: From -25 °C to +110 °C - Compatibility with fluids: Mineral oils, Synthetic fluids HFB and HFC according to ISO 2943 - Degree protection: IP66 according to EN 60529
2.0 bar ±10%	DE M 20 x F 10 P01		
5.0 bar ±10%	DE M 50 x F 10 P01		
7.0 bar ±10%	DE M 70 x F 10 P01		
9.5 bar ±10%	DE M 95 x F 10 P01		
		Electrical data - Electrical connection: AMP Superseal series 1.5 - Resistive load: 0.2 A / 115 Vdc - Switching type: Normally open contacts (NC on request) - Thermal lockout: Normally open up to 30 °C (option "F")	

DEM*F20		Hydraulic symbol	Materials
Electrical Differential Pressure Indicator AMP Time junior			
Settings	Ordering code		
1.2 bar ±10%	DE M 12 x F 20 P01	Electrical symbol 	Technical data - Max working pressure: 420 bar - Proof pressure: 630 bar - Burst pressure: 1260 bar - Working temperature: From -25 °C to +110 °C - Compatibility with fluids: Mineral oils, Synthetic fluids HFB and HFC according to ISO 2943 - Degree protection: IP66 according to EN 60529
2.0 bar ±10%	DE M 20 x F 20 P01		
5.0 bar ±10%	DE M 50 x F 20 P01		
7.0 bar ±10%	DE M 70 x F 20 P01		
9.5 bar ±10%	DE M 95 x F 20 P01		
		Electrical data - Electrical connection: AMP Time junior - Resistive load: 0.2 A / 115 Vdc - Switching type: Normally open contacts (NC on request) - Thermal lockout: Normally open up to 30 °C (option "F")	

DIFFERENTIAL PRESSURE INDICATORS

Dimensions

DEM*F30	
Electrical Differential Pressure Indicator Deutsch DT-04-2-P	
Settings	Ordering code
1.2 bar ±10%	DE M 12 x F 30 P01
2.0 bar ±10%	DE M 20 x F 30 P01
5.0 bar ±10%	DE M 50 x F 30 P01
7.0 bar ±10%	DE M 70 x F 30 P01
9.5 bar ±10%	DE M 95 x F 30 P01

A/F 28
Max tightening torque: 65 N·m

Hydraulic symbol

Electrical symbol

Thermal lockout

Materials

- Body: Brass
- Base: Black polyamide
- Contacts: Silver
- Seal: HNBR - FPM

Technical data

- Max working pressure: 420 bar
- Proof pressure: 630 bar
- Burst pressure: 1260 bar
- Working temperature: From -25 °C to +110 °C
- Compatibility with fluids: Mineral oils, Synthetic fluids
HFB and HFC according to ISO 2943
- Degree protection: IP66 according to EN 60529

Electrical data

- Electrical connection: Deutsch DT-04-2-P
- Resistive load: 0.2 A / 115 Vdc
- Switching type: Normally open contacts (NC on request)
- Thermal lockout: Normally open up to 30 °C (option "F")

DEM*F35	
Electrical Differential Pressure Indicator Deutsch DT-04-3-P	
Settings	Ordering code
1.2 bar ±10%	DE M 12 x F 35 P01
2.0 bar ±10%	DE M 20 x F 35 P01
5.0 bar ±10%	DE M 50 x F 35 P01
7.0 bar ±10%	DE M 70 x F 35 P01
9.5 bar ±10%	DE M 95 x F 35 P01

A/F 28
Max tightening torque: 65 N·m

Hydraulic symbol

Electrical symbol

Thermal lockout

Materials

- Body: Brass
- Base: Black polyamide
- Contacts: Silver
- Seal: HNBR - FPM

Technical data

- Max working pressure: 420 bar
- Proof pressure: 630 bar
- Burst pressure: 1260 bar
- Working temperature: From -25 °C to +110 °C
- Compatibility with fluids: Mineral oils, Synthetic fluids
HFB and HFC according to ISO 2943
- Degree protection: IP66 according to EN 60529

Electrical data

- Electrical connection: Deutsch DT-04-3-P
- Resistive load: 0.2 A / 115 Vdc
- Switching type: SPDT contact
- Thermal lockout: Normally open up to 30 °C (option "F")

DEM*A10	
Electrical Differential Pressure Indicator Connection: AMP Superseal series 1.5	
Settings	Ordering code
1.2 bar ±10%	DE M 12 x A 10 P01
2.0 bar ±10%	DE M 20 x A 10 P01
5.0 bar ±10%	DE M 50 x A 10 P01
7.0 bar ±10%	DE M 70 x A 10 P01
9.5 bar ±10%	DE M 95 x A 10 P01

A/F 28
Max tightening torque: 65 N·m

Hydraulic symbol

Electrical symbol

Materials

- Body: Brass
- Base: Black polyamide
- Contacts: Silver
- Seal: HNBR - FPM

Technical data

- Max working pressure: 420 bar
- Proof pressure: 630 bar
- Burst pressure: 1260 bar
- Working temperature: From -25 °C to +110 °C
- Compatibility with fluids: Mineral oils, Synthetic fluids
HFB and HFC according to ISO 2943
- Degree protection: IP66 according to EN 60529

Electrical data

- Electrical connection: AMP Superseal series 1.5
- Resistive load: 0.2 A / 115 Vdc
- Switching type: Normally open contacts (NC on request)

DEM*A20	
Electrical Differential Pressure Indicator AMP Time junior	
Settings	Ordering code
1.2 bar ±10%	DE M 12 x A 20 P01
2.0 bar ±10%	DE M 20 x A 20 P01
5.0 bar ±10%	DE M 50 x A 20 P01
7.0 bar ±10%	DE M 70 x A 20 P01
9.5 bar ±10%	DE M 95 x A 20 P01

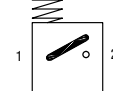
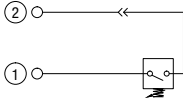

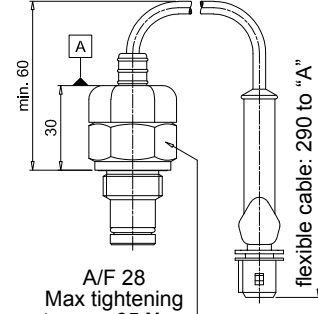
A/F 28
Max tightening torque: **65 N·m**

Materials

- Body: Brass
- Base: Black polyamide
- Contacts: Silver
- Seal: HNBR - FPM

Technical data

- Max working pressure: 420 bar
- Proof pressure: 630 bar
- Burst pressure: 1260 bar
- Working temperature: From -25 °C to +110 °C
- Compatibility with fluids: Mineral oils, Synthetic fluids
HFB and HFC according to ISO 2943
- Degree protection: IP66 according to EN 60529

Electrical data

- Electrical connection: AMP Time junior
- Resistive load: 0.2 A / 115 Vdc
- Switching type: Normally open contacts (NC on request)

DEM*A30	
Electrical Differential Pressure Indicator Deutsch DT-04-2-P	
Settings	Ordering code
1.2 bar ±10%	DE M 12 x A 30 P01
2.0 bar ±10%	DE M 20 x A 30 P01
5.0 bar ±10%	DE M 50 x A 30 P01
7.0 bar ±10%	DE M 70 x A 30 P01
9.5 bar ±10%	DE M 95 x A 30 P01

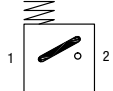
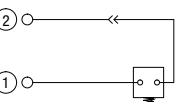

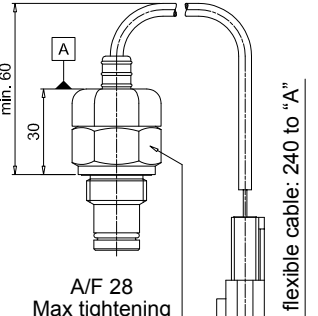
A/F 28
Max tightening torque: **65 N·m**

Materials

- Body: Brass
- Base: Black polyamide
- Contacts: Silver
- Seal: HNBR - FPM

Technical data

- Max working pressure: 420 bar
- Proof pressure: 630 bar
- Burst pressure: 1260 bar
- Working temperature: From -25 °C to +110 °C
- Compatibility with fluids: Mineral oils, Synthetic fluids
HFB and HFC according to ISO 2943
- Degree protection: IP66 according to EN 60529

Electrical data

- Electrical connection: Deutsch DT-04-2-P
- Resistive load: 0.2 A / 115 Vdc
- Switching type: Normally open contacts (NC on request)

DEM*A35	
Electrical Differential Pressure Indicator Deutsch DT-04-3-P	
Settings	Ordering code
1.2 bar ±10%	DE M 12 x A 35 P01
2.0 bar ±10%	DE M 20 x A 35 P01
5.0 bar ±10%	DE M 50 x A 35 P01
7.0 bar ±10%	DE M 70 x A 35 P01
9.5 bar ±10%	DE M 95 x A 35 P01

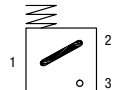
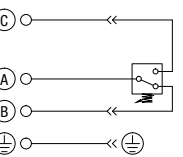

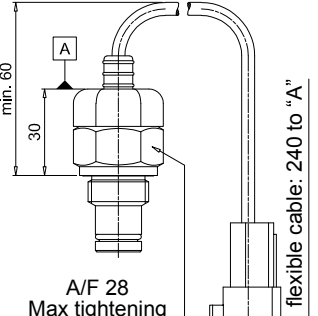
A/F 28
Max tightening torque: **65 N·m**

Materials

- Body: Brass
- Base: Black polyamide
- Contacts: Silver
- Seal: HNBR - FPM

Technical data

- Max working pressure: 420 bar
- Proof pressure: 630 bar
- Burst pressure: 1260 bar
- Working temperature: From -25 °C to +110 °C
- Compatibility with fluids: Mineral oils, Synthetic fluids
HFB and HFC according to ISO 2943
- Degree protection: IP66 according to EN 60529

Electrical data

- Electrical connection: Deutsch DT-04-3-P
- Resistive load: 0.2 A / 115 Vdc
- Switching type: SPDT contact

DIFFERENTIAL PRESSURE INDICATORS

Dimensions

DES*10	
Electrical Differential Pressure Indicator AMP Superseal series 1.5	
Settings	Ordering code
1.2 bar $\pm 10\%$	DE S 12 H A 10 P01
2.5 bar $\pm 10\%$	DE S 25 H A 10 P01
4.0 bar $\pm 10\%$	DE S 40 H A 10 P01

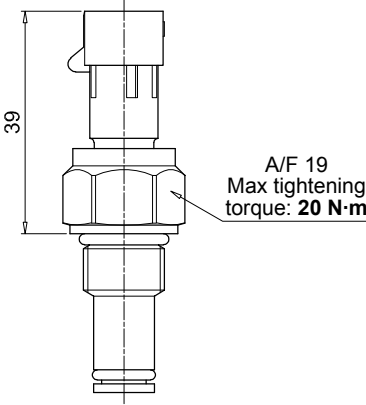

Hydraulic symbol

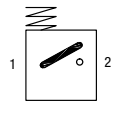

Electrical symbol

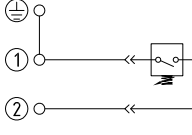

Materials

- Body: Brass
- Internal parts: Brass - Polyamide
- Contacts: Silver
- Seal: HNBR

Technical data

- Max working pressure: 16 bar
- Proof pressure: 24 bar
- Burst pressure: 48 bar
- Working temperature: From -25 °C to +110 °C
- Compatibility with fluids: Mineral oils, Synthetic fluids

- Degree protection: IP67 according to EN 60529

Electrical data

- Electrical connection: AMP Superseal series 1.5
- Resistive load: 0.2 A / 24 Vdc
- Switching type: Normally open contacts (NC on request)

DES*30	
Electrical Differential Pressure Indicator Deutsch DT-04-2-P	
Settings	Ordering code
1.2 bar $\pm 10\%$	DE S 12 H A 30 P01
2.5 bar $\pm 10\%$	DE S 25 H A 30 P01
4.0 bar $\pm 10\%$	DE S 40 H A 30 P01

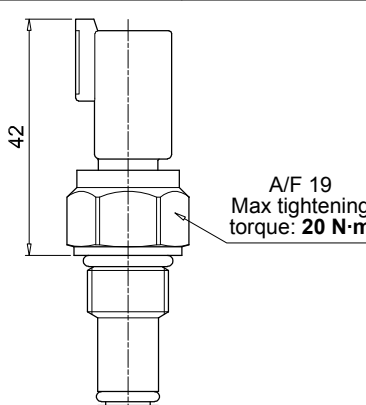

Hydraulic symbol

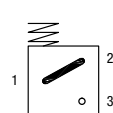

Electrical symbol

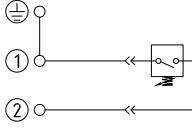

Materials

- Body: Brass
- Internal parts: Brass - Polyamide
- Contacts: Silver
- Seal: HNBR

Technical data

- Max working pressure: 16 bar
- Proof pressure: 24 bar
- Burst pressure: 48 bar
- Working temperature: From -25 °C to +110 °C
- Compatibility with fluids: Mineral oils, Synthetic fluids

- Degree protection: IP67 according to EN 60529

Electrical data

- Electrical connection: Deutsch DT-04-2-P
- Resistive load: 0.2 A / 24 Vdc
- Switching type: Normally open contacts (NC on request)

DES*80	
Electrical Differential Pressure Indicator Stud #10-32 UNF	
Settings	Ordering code
1.2 bar $\pm 10\%$	DE S 12 H A 80 P01
2.5 bar $\pm 10\%$	DE S 25 H A 80 P01
4.0 bar $\pm 10\%$	DE S 40 H A 80 P01

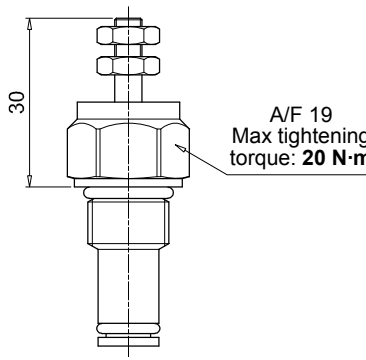

Hydraulic symbol

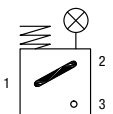

Electrical symbol

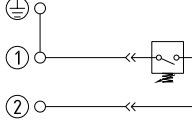

Materials

- Body: Brass
- Internal parts: Brass - Polyamide
- Contacts: Silver
- Seal: HNBR

Technical data

- Max working pressure: 16 bar
- Proof pressure: 24 bar
- Burst pressure: 48 bar
- Working temperature: From -25 °C to +110 °C
- Compatibility with fluids: Mineral oils, Synthetic fluids

- Degree protection: IP67 according to EN 60529

Electrical data

- Electrical connection: Stud #10-32 UNF
- Resistive load: 0.2 A / 24 Vdc
- Switching type: Normally open contacts (NC on request)

DEU*50 UL	
Electrical Differential Pressure Indicator Connection EN 175301-803	
Settings	Ordering code
2.0 bar ±10%	DE U 20 H A 50 P01 UL
5.0 bar ±10%	DE U 50 H A 50 P01 UL
7.0 bar ±10%	DE U 70 H A 50 P01 UL

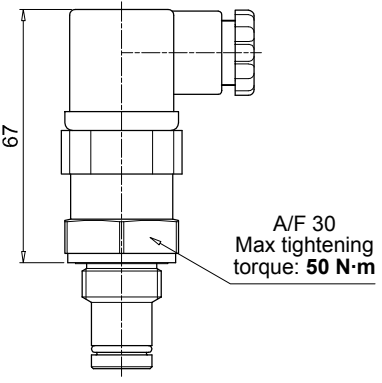

Hydraulic symbol

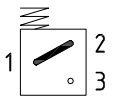

Electrical symbol

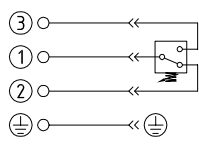

 - Certification: UL
- Certification included in EX version

Materials

- Body: Brass
- Base: Black Polyamide
- Contacts: Silver
- Seal: HNBR

Technical data

- Max working pressure: 210 bar
- Proof pressure: 220 bar
- Burst pressure: 880 bar
- Working temperature: From -25 °C to +85 °C
- Compatibility with fluids: Mineral oils, Synthetic fluids
HFB and HFC according to ISO 2943
- Degree protection: IP65 according to EN 60529

Electrical data

- Electrical connection: EN 175301-803
- Resistive load: 3 A / 30 Vdc
3 A / 125 Vac
3 (3) A / 250 Vac

DEX*50	
Electrical Differential Pressure Indicator Connection: EN 175301-803	
Settings	Ordering code
1.2 bar ±10%	DE X 12 x A 50 P01
2.0 bar ±10%	DE X 20 x A 50 P01
5.0 bar ±10%	DE X 50 x A 50 P01
7.0 bar ±10%	DE X 70 x A 50 P01
9.5 bar ±10%	DE X 95 x A 50 P01

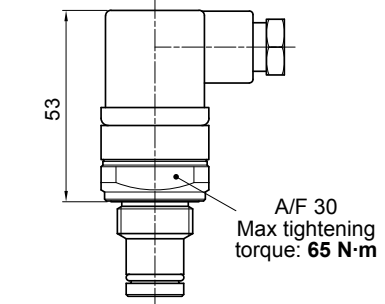

Hydraulic symbol

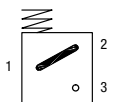

Electrical symbol

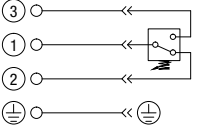

 - Certification: UL
- Certification included in EX version

Materials

- Body: AISI 316L
- Base: Black polyamide
- Contacts: Silver
- Seal: HNBR - MFQ

Technical data

- Max working pressure: 420 bar
- Proof pressure: 630 bar
- Burst pressure: 1260 bar
- Working temperature: From -25 °C to +110 °C
- Compatibility with fluids: Mineral oils, Synthetic fluids
HFB and HFC according to ISO 2943
- Degree protection: IP66 according to EN 60529
IP69K according to ISO 20653

Electrical data

- Electrical connection: EN 175301-803
- Resistive load: 0.2 A / 115 Vdc

DEZ*50	
Electrical Differential Pressure Indicator Connection: EN 175301-803	
Settings	Ordering code
1.2 bar ±10%	DE Z 12 x A 50 P01
2.0 bar ±10%	DE Z 20 x A 50 P01
5.0 bar ±10%	DE Z 50 x A 50 P01
7.0 bar ±10%	DE Z 70 x A 50 P01
9.5 bar ±10%	DE Z 95 x A 50 P01

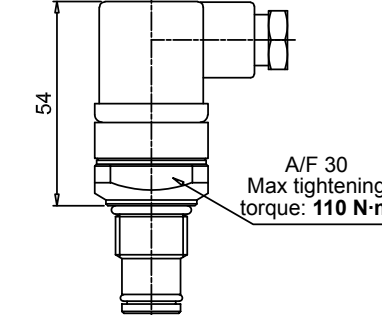

Hydraulic symbol

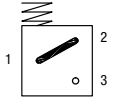

Electrical symbol

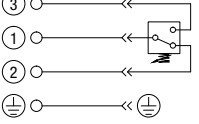

 - Certification: UL
- Certification included in EX version

Materials

- Body: AISI 316L
- Base: Black polyamide
- Contacts: Silver
- Seal: HNBR - MFQ

Technical data

- Max working pressure: 700 bar
- Proof pressure: 1050 bar
- Burst pressure: 2100 bar
- Working temperature: From -25 °C to +110 °C
- Compatibility with fluids: Mineral oils, Synthetic fluids
HFA, HFB, HFC according to ISO 2943
- Degree protection: IP66 according to EN 60529
IP69K according to ISO 20653

Electrical data

- Electrical connection: EN 175301-803
- Resistive load: 0.2 A / 115 Vdc

DLE*F50

Electrical/Visual Differential Pressure Indicator
With term. Connections: EN 175301-803

Settings	Ordering code
1.2 bar ±10%	DL E 12 x F 50 P01
2.0 bar ±10%	DL E 20 x F 50 P01
5.0 bar ±10%	DL E 50 x F 50 P01
7.0 bar ±10%	DL E 70 x F 50 P01
9.5 bar ±10%	DL E 95 x F 50 P01

A/F 32
Max tightening torque: 95 N·m

Hydraulic symbol

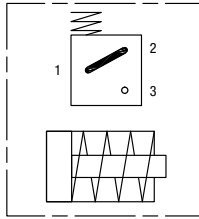

Electrical symbol

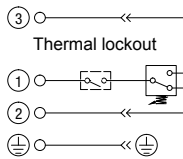

Materials

- Body: Brass
- Base: Black polyamide
- Contacts: Silver
- Seal: HNBR - FPM

Technical data

- Max working pressure: 420 bar
- Proof pressure: 630 bar
- Burst pressure: 1260 bar
- Working temperature: From -25 °C to +110 °C
- Compatibility with fluids: Mineral oils, Synthetic fluids
HFB and HFC according to ISO 2943
- Degree protection: IP65 according to EN 60529

Electrical data

- Electrical connections: EN 175301-803
- Resistive load: 5 A / 250 Vdc
- Thermal lockout setting: +30 °C

DLX*51 - DLX*52

Electrical/Visual Differential Pressure Indicator
Connection: EN 175301-803

51: Transparent base with lamps 24 Vdc
52: Transparent base with lamps 110 Vdc

Settings	Ordering code
1.2 bar ±10%	DL X 12 x A 5x P01
2.0 bar ±10%	DL X 20 x A 5x P01
5.0 bar ±10%	DL X 50 x A 5x P01
7.0 bar ±10%	DL X 70 x A 5x P01
9.5 bar ±10%	DL X 95 x A 5x P01

A/F 30
Max tightening torque: 65 N·m

Hydraulic symbol

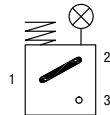

Electrical symbol

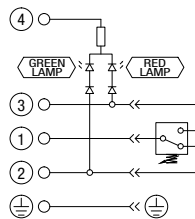

Materials

- Body: AISI 316L
- Base: Transparent polyamide
- Contacts: Silver
- Seal: HNBR - MFQ

Technical data

- Max working pressure: 420 bar
- Proof pressure: 630 bar
- Burst pressure: 1260 bar
- Working temperature: From -25 °C to +110 °C
- Compatibility with fluids: Mineral oils, Synthetic fluids
HFB and HFC according to ISO 2943
- Degree protection: IP66 according to EN 60529
IP69K according to ISO 20653

Electrical data

- Electrical connection: EN 175301-803
- Type: 51 52
- Lamps: 24 Vdc 110 Vdc
- Resistive load: 1 A / 24 Vdc 1 A / 110 Vdc

DLZ*51 - DLZ*52

Electrical/Visual Differential Pressure Indicator
Connection: EN 175301-803

51: Transparent base with lamps 24 Vdc
52: Transparent base with lamps 110 Vdc

Settings	Ordering code
1.2 bar ±10%	DL Z 12 x A 5x P01
2.0 bar ±10%	DL Z 20 x A 5x P01
5.0 bar ±10%	DL Z 50 x A 5x P01
7.0 bar ±10%	DL Z 70 x A 5x P01
9.5 bar ±10%	DL Z 95 x A 5x P01

A/F 30
Max tightening torque: 110 N·m

Hydraulic symbol

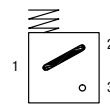

Electrical symbol

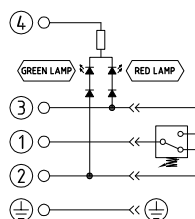

Materials

- Body: AISI 316L
- Base: Transparent polyamide
- Contacts: Silver
- Seal: HNBR - MFQ

Technical data

- Max working pressure: 700 bar
- Proof pressure: 1050 bar
- Burst pressure: 2100 bar
- Working temperature: From -25 °C to +110 °C
- Compatibility with fluids: Mineral oils, Synthetic fluids
HFB and HFC according to ISO 2943
- Degree protection: IP66 according to EN 60529
IP69K according to ISO 20653

Electrical data

- Electrical connection: EN 175301-803
- Type: 51 52
- Lamps: 24 Vdc 110 Vdc
- Resistive load: 1 A / 24 Vdc 1 A / 110 Vdc

DIFFERENTIAL PRESSURE INDICATORS

Dimensions

DTA*F70	
Electronic Differential Pressure Indicator Connection: IEC 61076-2-101 D (M12)	
Settings	Ordering code
1.2 bar ±10%	DT A 12 x F 70 P01
2.0 bar ±10%	DT A 20 x F 70 P01
5.0 bar ±10%	DT A 50 x F 70 P01
7.0 bar ±10%	DT A 70 x F 70 P01
9.5 bar ±10%	DT A 95 x F 70 P01

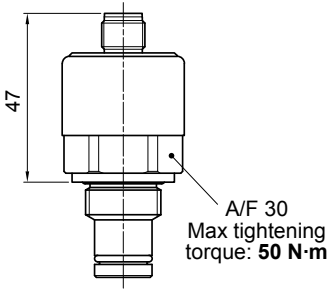

47
A/F 30
Max tightening torque: 50 N·m

Hydraulic symbol

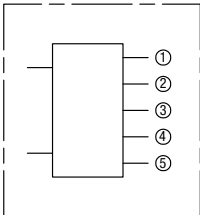

Electrical symbol

①	○	○	+24 Vdc
②	○	○	4 ÷ 20 mA
③	○	○	75% - N.O. Digital output
④	○	○	100% - N.O. Digital output
⑤	○	○	0 Vdc

Materials

- Body: Brass
- Internal parts: Brass - Polyamide
- Contacts: Silver
- Seal: HNBR - FPM

Technical data

- Max working pressure: 420 bar
- Proof pressure: 630 bar
- Burst pressure: 1260 bar
- Compatibility with fluids: Mineral oils, Synthetic fluids
HFB and HFC according to ISO 2943
- Degree protection: IP67 according to EN 60529

Electrical data

- Electrical connection: IEC 61076-2-101 D (M12)
- Power supply: 24 Vdc
- Analogue output: From 4 to 20 mA
- Thermal lockout: 30 °C (all output signals stalled up to 30 °C)

DVA	
Visual Differential Pressure Indicator	
Settings	Ordering code
1.2 bar ±10%	DV A 12 x P01
2.0 bar ±10%	DV A 20 x P01
5.0 bar ±10%	DV A 50 x P01
7.0 bar ±10%	DV A 70 x P01
9.5 bar ±10%	DV A 95 x P01

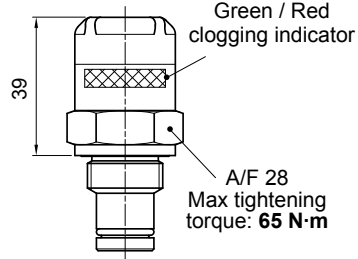

39
Green / Red
clogging indicator
A/F 28
Max tightening torque: 65 N·m

Hydraulic symbol

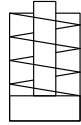

Materials

- Body: Brass
- Internal parts: Brass - Polyamide
- Seal: HNBR - FPM

Technical data

- Reset: Automatic reset
- Max working pressure: 420 bar
- Proof pressure: 630 bar
- Burst pressure: 1260 bar
- Working temperature: From -25 °C to +110 °C
- Compatibility with fluids: Mineral oils, Synthetic fluids
HFB and HFC according to ISO 2943
- Degree protection: IP65 according to EN 60529

DVM	
Visual Differential Pressure Indicator	
Settings	Ordering code
1.2 bar ±10%	DV M 12 x P01
2.0 bar ±10%	DV M 20 x P01
5.0 bar ±10%	DV M 50 x P01
7.0 bar ±10%	DV M 70 x P01
9.5 bar ±10%	DV M 95 x P01

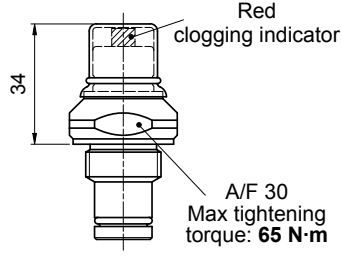

34
Red
clogging indicator
A/F 30
Max tightening torque: 65 N·m

Hydraulic symbol

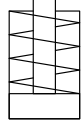

Materials

- Body: Brass
- Internal parts: Brass - Polyamide
- Seal: HNBR - FPM

Technical data

- Reset: Manual reset
- Max working pressure: 420 bar
- Proof pressure: 630 bar
- Burst pressure: 1260 bar
- Working temperature: From -25 °C to +110 °C
- Compatibility with fluids: Mineral oils, Synthetic fluids
HFB and HFC according to ISO 2943
- Degree protection: IP65 according to EN 60529

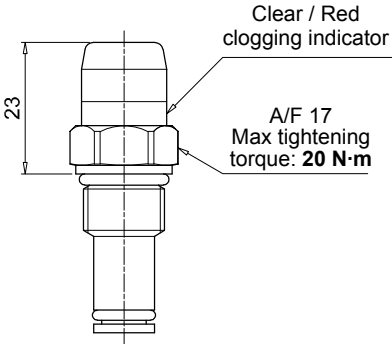
DVS		Hydraulic symbol	Materials - Body: Brass - Internal parts: Brass - Polyamide - Seal: HNBR
Visual Differential Pressure Indicator			
Settings	Ordering code		
1.2 bar ±10%	DV S 12 H P01		
2.5 bar ±10%	DV S 25 H P01		
4.0 bar ±10%	DV S 40 H P01		
 <p style="text-align: center;">Clear / Red clogging indicator</p> <p style="text-align: center;">A/F 17 Max tightening torque: 20 N·m</p>			

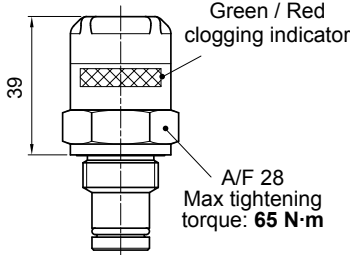
DVX		Hydraulic symbol	Materials - Body: AISI 316L - Internal parts: AISI 316L - Polyamide - Seal: HNBR - MFQ
Visual Differential Pressure Indicator			
Settings	Ordering code		
1.2 bar ±10%	DV X 12 x P01		
2.0 bar ±10%	DV X 20 x P01		
5.0 bar ±10%	DV X 50 x P01		
7.0 bar ±10%	DV X 70 x P01		
9.5 bar ±10%	DV X 95 x P01		
 <p style="text-align: center;">Green / Red clogging indicator</p> <p style="text-align: center;">A/F 28 Max tightening torque: 65 N·m</p>			

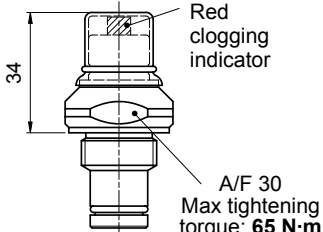
DVY		Hydraulic symbol	Materials - Body: AISI 316L - Internal parts: AISI 316L - Polyamide - Seal: HNBR - MFQ
Visual Differential Pressure Indicator			
Settings	Ordering code		
1.2 bar ±10%	DV Y 12 x P01		
2.0 bar ±10%	DV Y 20 x P01		
5.0 bar ±10%	DV Y 50 x P01		
7.0 bar ±10%	DV Y 70 x P01		
9.5 bar ±10%	DV Y 95 x P01		
 <p style="text-align: center;">Red clogging indicator</p> <p style="text-align: center;">A/F 30 Max tightening torque: 65 N·m</p>			

DIFFERENTIAL PRESSURE INDICATORS

Dimensions

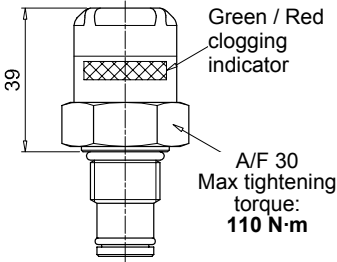
DVZ		Hydraulic symbol	Materials
Visual Differential Pressure Indicator			
Settings	Ordering code		
1.2 bar ±10%	DV Z 12 x P01	Technical data - Reset: Automatic reset - Max working pressure: 700 bar - Proof pressure: 1050 bar - Burst pressure: 2100 bar - Working temperature: From -25 °C to +110 °C - Compatibility with fluids: Mineral oils, Synthetic fluids HFB and HFC according to ISO 2943 - Degree protection: IP65 according to EN 60529	
2.0 bar ±10%	DV Z 20 x P01		
5.0 bar ±10%	DV Z 50 x P01		
7.0 bar ±10%	DV Z 70 x P01		
9.5 bar ±10%	DV Z 95 x P01		
			

T2	
Plug	
Seal	Ordering code
HNBR	T2 H
FPM	T2 V

Materials

- Body: Phosphatized steel
- Seal: HNBR / FPM

A/F 30
Max tightening torque: 50 N·m

T4	
Plug	
Seal	Ordering code
NBR	T4 A

Materials

- Body: Anodized aluminium
- Seal: NBR

A/F 19
Max tightening torque: 20 N·m

X2	
Stainless Steel plug 420 bar	
Seal	Ordering code
HNBR	X2 H
FPM	X2 F
MFQ	X2 Q

Materials

- Body: AISI 316L
- Seal: HNBR / FPM / MFQ

A/F 30
Max tightening torque: 50 N·m

X3	
Stainless Steel plug 700 bar (only for FZH)	
Seal	Ordering code
HNBR	X3 H
FPM	X3 F
MFQ	X3 Q

Materials

- Body: AISI 316L
- Seal: HNBR / FPM / MFQ

A/F 30
Max tightening torque: 110 N·m

All data, details and words contained in this publication are provided for use by technically qualified personnel at their discretion, without warranty of any kind.

MP Filtri reserves the right to make modifications to the models and versions of the described products at any time for both technical and/or commercial reasons.

For updated information please visit our website: www.mpfiltri.com

The colors and the pictures of the products are purely indicative.

Any reproduction, partial or total, of this document is strictly forbidden.

All rights are strictly reserved



WORLDWIDE NETWORK

CANADA ♦ CHINA ♦ FRANCE ♦ GERMANY ♦ INDIA ♦ SINGAPORE
UNITED ARAB EMIRATES ♦ UNITED KINGDOM ♦ USA



PASSION  PERFORM

in @ y f



mpfiltri.com

MP Filtri reserves the right to make modifications to the models and versions of the described products at any time for both technical and/or commercial reasons. For updated information please visit our website: www.mpfiltri.com. The colors and the pictures of the products are purely indicative. Any reproduction, partial or total, of this document is strictly forbidden. All rights are strictly reserved.

MF001000017
EN - 2024.11